



www.hy-lok.com

Catalog No. H-200TF
Jan. 2011



Two Ferrule Tube Fittings

size from 1/16" thru 2" (2mm thru 42mm)



- ECE R110 compliance 1/8"(3mm) to 1"(25mm), for NGV application.
- EIHP compliance 1/8"(3mm) to 1"(25mm), for hydrogen application.



HY-LOK CORPORATION

© 1998, 2000, 2001, 2002, 2005, 2010, 2011 HY-LOK CORPORATION All rights reserved

Main Index

○ Introduction	3
○ General Technical	4
○ Index	10
○ Hy-Lok Two Ferrule Tube Fittings	13
○ Tools	67
○ Installation Instructions	70





Design and Manufacture

Hy-Lok two ferrule tube fittings have been designed and manufactured with great care to meet the specifications required for a wide range of applications in chemical, petro-chemical, oil refineries, power generation, shipbuilding, pulp and papers, micro-electronics, etc. Each Hy-Lok tube fitting consists of four parts; body, front ferrule, back ferrule, and nut. The two-ferrule design, front and back, compensates for any tolerances in tube O.D., wall thickness, material hardness and always ensures outstanding leak-tight connections.

Hy-Lok two ferrule tube fittings are manufactured under Hy-Lok Corporation's strict quality control program which enabled Hy-Lok to obtain ASME Quality System Certificate and ISO 9001.

Torque and Distortion during Installation

When the nut is tightened, the back and front ferrules move axially. This axial movement does not allow any torque transfer from the fitting to the tubing, and the mechanical properties of tubing are maintained.

During makeup, the back ferrule moves in such a controlled manner that the tubing is not overstressed and the tubing I.D. is not excessively reduced, resulting in safe operation under high pressure or vibration. The front ferrule does not force the body to expand, which allows the nut to be back off easily for disassembly and allows multiple remakes.

Easy Reference

Heads of tables are differentiated with color ;

- Shows Fractional
- Shows Metric

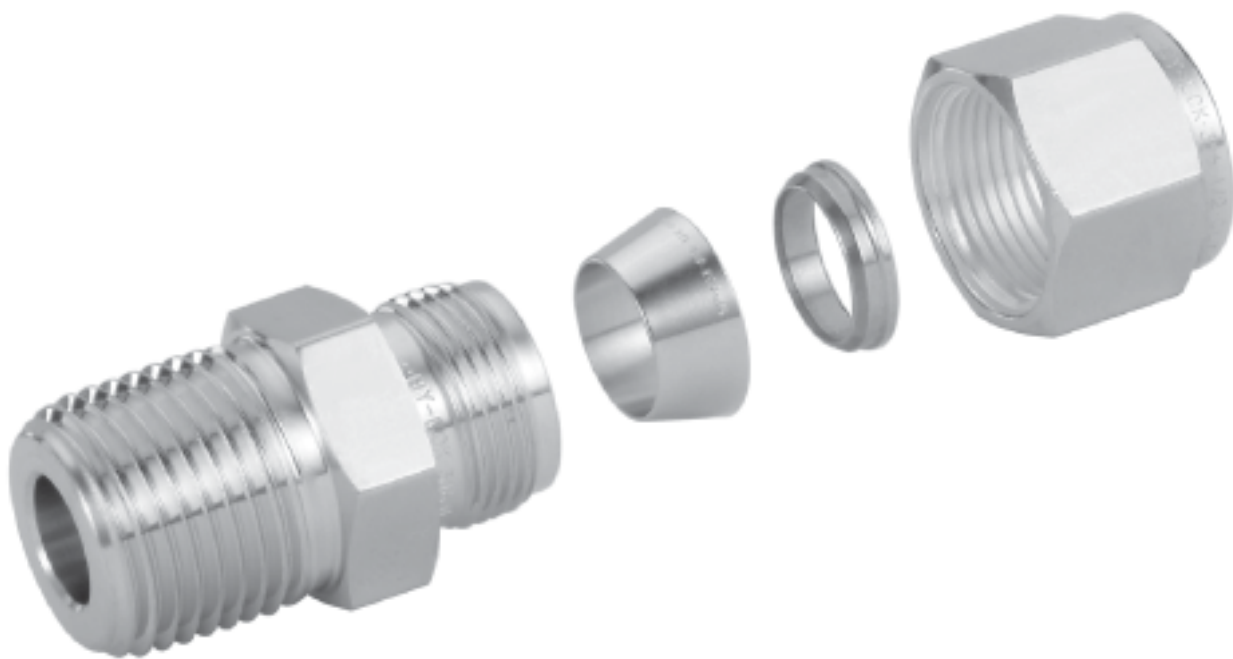

Hy-Lok Two Ferrule Tube Fittings

Materials

Material	Bar Stock	Forging
Stainless Steel Type 316	ASTM A479, ASTM A276, ASME SA479	ASTM A182, ASME SA182
BRASS	ASTM B16 Alloy 360, ASTM B453 Alloy 345	ASTM B283 Alloy 377
Carbon Steel	ASTM A108	ASTM A576
Alloy 20	ASTM B473	ASTM B462
Alloy 400	ASTM B164, ASME SB164	ASTM B564, ASME SB564
Alloy 600	ASTM B166, ASME SB166	ASTM B564, ASME SB564
Alloy 625	ASTM B446	ASTM B564, ASME SB564
Alloy 825	ASTM B425	ASTM B564, ASME SB564
Alloy C-276	ASTM B574	ASTM B564
Titanium	ASTM B348	ASTM B381
Aluminum	ASTM B211	ASTM B247
SAF 2507	ASTM A479	ASTM A182
Nylon	ASTM D4066	-
PTFE	ASTM D1710	ASTM D3294

■ Carbon Steel Hy-Lok two ferrule tube fittings are supplied with 316 stainless steel back ferrule.

Pressure Ratings

Hy-Lok two ferrule tube fittings are rated to the maximum working pressure of tubing recommended for use with Hy-Lok two ferrules tube fittings.

The maximum working pressure of tubings are listed in **MAWP Table** on the following pages.

Note : Material strength and allowable working pressure decrease as the temperature increases.

Temperature Ratings

The following temperature ratings are applicable.

- 316 Stainless Steel : -321°F to 1200°F (-196°C to 649°C)
- Brass : -65°F to 400°F (-54°C to 204°C)
- Monel : -65°F to 800°F (-54°C to 427°C)

Tubing

Variety of tubing materials and wide range of wall thickness can be used with Hy-Lok two ferrule tube fittings. However, it is essential to specify, select, and handle the tubing with care in order to ensure reliable, safe, leak tight installation using Hy-Lok two ferrule tube fittings.

Some general rules are shown below.

1. The tubing material must be compatible with process fluid.
2. Temperature, pressure, vibration and shock conditions must be considered when selecting the wall thickness, Further, extremely thick wall may not be properly deformed and extremely thin wall may be collapsed by ferrule action.
3. The metal tubing must be softer than the fitting materials. In general, metal tubing should be fully annealed to work properly with Hy-Lok two ferrule tube fittings.
4. For leak tight installation, the tubing surface finish must be smooth and free from weld seam, scratches and draw marks.
5. The tubing with high tolerance in ovality or O.D. may not fit in the fitting or may cause improper performance.
6. Best performance is achieved when the tubing ends are squarely cut and deburred properly.

The followings are the recommended tubing specifications for best performance with Hy-Lok two ferrule tube fittings.

Stainless Steel Tubing

Fully annealed seamless type 304, 316 to ASTM A269 or equivalent with hardness Rockwell Rb90 or less.

Copper Tubing

Seamless soft annealed temper O60 with hardness 60 max.(Rockwell hardness, 15T) to ASTM B75, or seamless water tubing type K or type L annealed temper O60 with hardness 50 max. in coils or annealed temper O50 with hardness 55 max.(Rockwell hardness, F) in straight lengths to ASTM B88, or equivalent.

Monel Tubing

Fully annealed seamless Alloy 400 to ASTM B165 or equivalent with hardness Rb75 max.



Gas Service

Gases have very small molecules and can escape through minute leak paths due to surface imperfections. These imperfections can be coined out when heavy wall tubing is used as it resists the ferrule action more than thin wall does. The minimum wall thickness for gas service is shown below.

Fractional Tubing

Tubing O.D.	Nominal Min. Wall Thickness	Tubing O.D.	Nominal Min. Wall Thickness
1/8"	.028"	3/4"	.065"
3/16"	.028"	7/8"	.083"
1/4"	.028"	1"	.083"
5/16"	.035"	1 1/4"	.109"
3/8"	.035"	1 1/2"	.134"
1/2"	.049"	2"	.180"
5/8"	.065"		

Metric Tubing

Tubing O.D.	Nominal Min. Wall Thickness	Tubing O.D.	Nominal Min. Wall Thickness
3mm	0.8mm	18mm	1.5mm
6mm	0.8mm	20mm	1.8mm
8mm	1.0mm	22mm	2.0mm
10mm	1.0mm	25mm	2.2mm
12mm	1.0mm	28mm	2.8mm
14mm	1.2mm	32mm	3.0mm
16mm	1.5mm	38mm	3.5mm

Temperature Derating

The working pressure varies depending upon the temperature. The working pressure at various temperatures can be obtained by multiplying the working pressure at ambient temperature (-20°F to 100°F or -29°C to 37°C) by the temperature derating factor in the table shown below.

Temperature(°F)	316SS	304SS	Copper	Monel 400
100	1.00	1.00	1.00	1.00
200	1.00	0.84	0.80	0.88
300	1.00	0.75	0.78	0.82
400	0.96	0.69	0.50	0.79
500	0.90	0.65	-	0.79
600	0.85	0.61	-	0.79
700	0.82	0.59	-	0.76
800	0.79	0.56	-	0.76
900	0.78	0.54	-	-
1000	0.76	0.52	-	-
1100	0.62	0.47	-	-
1200	0.37	0.31	-	-

Example

To obtain the working pressure of 316SS 3/8" O.D. x 0.035" wall tube at 1,200°F

- Working pressure of the above tubing at ambient temperature : 3,300 psig
- Temperature derating factor at 1,200°F : 0.37
- Working pressure at 1,200°F : 1,221 psig (from 3,300 psig multiplied by 0.37)

Tube Bends near Fitting

For leak tight installation, tube bends must not be too close to the fitting. the following is the recommended minimum straight length of tube measured from the tube end to the bend.

Tube O.D.	1/8"	1/4"	3/8"	1/2"	3/4"	1"	1 1/4"	1 1/2"	2"
Min. Length	23/32"	13/16"	15/16"	1 3/16"	1 1/4"	1 1/2"	2"	2 13/32"	3 1/4"

Also, the bending radius should not be too short of bending radius may affect the working pressure and may cause insufficient flow. Minimum bending radius is usually recommended by the tube bender manufacturer.

Tube Selection and Handling

Hy-Lok two ferrule tube fittings perform best when good quality tubing is used.

Tubing should be considered a fitting component.

Tubing selection by relying only on ASTM or other equivalent specifications is not enough. Here are some points to be considered.

1. Materials and manufacturing method
2. Material hardness
3. Surface finish
4. Outside diameter and its tolerance
5. Wall thickness and its tolerance
6. Ovality
7. Concentricity
8. Packing and transportation

Always try to use good quality tubing for best performance.

Tubings must be handled with great care in transportation and in storage. To avoid damage to the tubing surface. Copper tubings must not be crushed or lose its circularity. If necessary, the tubing must be covered and tubing ends must be plugged to be kept from dirt.

Hy-Lok Two Ferrule Tube Fittings

Maximum Allowable Working Pressure (MAWP) Table

Working pressure calculated in accordance with ASME B31.3, Chemical Plant and Petroleum Refinery Piping Code, 2002 Edition

Table 5. Stainless Steel Tubing

Fully annealed 304 or 316 high quality seamless stainless steel tube to ASTM A269 or equivalent.

Hardness : Rb90 or less

Stainless Steel Tube Inch Size																					
Tube O.D. (Inches)	Tube Wall Thickness in Inches																				
	0.010	0.012	0.014	0.016	0.020	0.028	0.035	0.049	0.065	0.083	0.095	0.109	0.120	0.134	0.156	0.188					
1/16"	5,600	6,800	8,200	9,600	12,600																
1/8"						8,500	11,200														
3/16"						5,400	7,000	10,400													
1/4"						4,000	5,100	7,500	10,400												
5/16"							4,000	5,800	8,000												
3/8"								3,300	4,800	6,500											
1/2"									2,600	3,700	5,100	6,700									
5/8"										2,900	4,000	5,200	6,000								
3/4"											2,400	3,300	4,200	4,900	5,800						
7/8"												2,000	2,800	3,600	4,200	4,800					
1"													2,400	3,100	3,600	4,200	4,700				
1 1/4"														2,500	2,800	3,300	3,600	4,100	4,900		
1 1/2"																2,300	2,700	3,000	3,400	4,000	4,900
2"																	2,000	2,200	2,500	2,900	3,600

Stainless Steel Tube Metric Size																
Tube O.D. (mm)	Tube Wall Thickness in Millimeters															
	0.8	1	1.2	1.5	1.8	2	2.2	2.5	2.8	3	3.5	4	4.5	5		
3	720	950														
4	520	670	840													
6	330	430	520	680												
8		310	380	490												
10		240	300	380	470	530										
12		200	240	310	380	430										
14		180	220	280	340	390	430									
15		170	200	260	320	360	400									
16			190	240	300	330	370	430								
18			170	210	260	290	330	380								
20			150	190	230	260	290	330	380							
22			140	170	210	240	260	300	340							
25				150	180	200	230	260	300	320						
28						180	200	230	260	280	330					
30							170	190	210	240	260	310				
32								160	170	200	230	240	290	330		
38									140	170	190	200	240	280	310	
50												150	180	210	230	260

- Allowable stress of 20,000psi (137,800kPa) between -20°F and 100°F (-29°C and 37°C) based on ultimate tensile strength 75,000psi (516,700kPa)
- Based on minimum wall thickness and maximum O.D. allowable by ASTM A269
- For welded tubing, the following derating rate to be applied for weld integrity. (ASME B31.3 - 2002 Edition, Table A - 1B)
 - for double welded tubing : 0.85
 - for single welded tubing : 0.80
- To determine bar, multiply psig by 0.0689 and to determine kPa by 6.89

Note :

1. All calculations are based on maximum outside diameter and minimum wall thickness without allowance for corrosion and erosion.
2. Care should be taken for temperature rating if tubing is coated or plated.
3. Figures shown are not for design purpose but for reference only and the accuracy of information here is not liability of our company.



Table 6. Copper Tubing

High quality soft annealed seamless copper tube to ASTM B - 75 or equivalent.
Hardness : Rockwell 15T 60 or less

Fractional Copper Tubing										
Tube O.D. (Inches)	Tube Wall Thickness in Inches									
	0.010	0.012	0.028	0.035	0.049	0.065	0.083	0.095	0.109	0.120
1/16"	1,652	2,124	6,742	9,871						
1/8"			2,804	3,787						
3/16"			1,810	2,343	3,615					
1/4"			1,321	1,696	2,565	3,639				
5/16"				1,329	1,988	2,782				
3/8"				1,093	1,623	2,251				
1/2"				806	1,187	1,630	2,160			
5/8"					935	1,277	1,681	1,970		
3/4"					748	1,017	1,332	1,555	1,823	
7/8"					639	867	1,133	1,320	1,544	
1"					559	756	986	1,147	1,339	1,479

Metric Copper Tubing										
Tube O.D. (mm)	Tube Wall Thickness in Millimeters									
	0.8	1.0	1.2	1.5	1.8	2.0	2.2	2.5	2.8	3.0
3	239	326								
4	175	228	291							
6	111	142	178	237	299					
8	81	103	128	168	210					
10	64	81	100	131	162	184				
12	53	67	82	107	131	149				
14		57	70	90	111	125	139	162		
15		53	65	84	102	116	129	150		
16		49	61	78	96	108	120	139		
18		43	53	68	83	94	104	121	138	150
20		39	47	61	75	84	93	107	123	133
22		35	43	55	67	76	84	97	110	120
25		31	38	48	59	66	73	84	96	104

- Allowable stress of 6,000psi (41,300kPa) between -20°F and 100°F (-29°C and 37°C) based on ultimate tensile strength 30,000psi (206,700kPa)
- Based on minimum wall thickness and maximum O.D. allowable by ASTM B75
- To determine bar, multiply psig by 0.0689 and to determine kPa by 6.89.

Table 7. Monel 400 Tubing

Fully annealed seamless Monel 400 to ASTM B165 or equivalent.
Hardness : Rb75 or less

Monel 400 Fractional Tubing										
Tube O.D. (Inches)	Tube Wall Thickness in Inches									
	0.010	0.012	0.028	0.035	0.049	0.065	0.083	0.095	0.109	0.120
1/8"			7,900	10,100						
1/4"			3,700	4,800	7,000	9,500				
3/8"	For gas service, applying			3,100	4,400	6,100				
1/2"	tube wall thickness only			2,300	3,200	4,400				
3/4"	on outside of shade boundary				2,200	3,000	4,000	4,600		
1"					2,200	2,900	3,400	3,900	4,300	

Hy-Lok Two Ferrule Tube Fittings

Identification of Hy-Lok Metric Two Ferrule Tube Fittings from Fractional

These two are similar in appearance. To avoid any confusion and for ready identification, the stepped shoulders are machined on the body and on the hex nut of metric size tube fittings as shown. The metric tube nut must not be used on fractional body, and vice versa

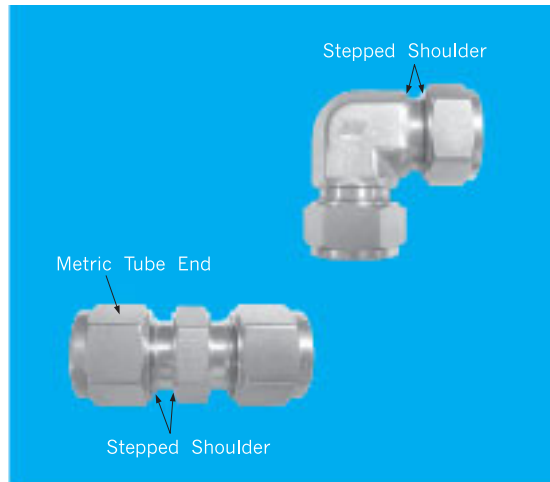

ISO Parallel and Tapered Pipe Thread

International Standards Organization(ISO) standardized the nomenclature of some international pipe threads. ISO 228/1 is a parallel thread and ISO 7/1 is a tapered thread. With 228/1 parallel thread, the seal is usually made by metal-to-metal contact against the female port or with a gasket. Shown below are two different seals. There are several different descriptions as listed below.

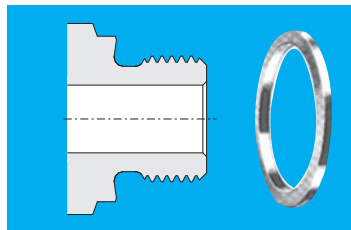

ISO Parallel with Metal Gasket Seal

A metal(usually copper) gasket performs the sealing between the reverse bevel of the fitting and the surface surrounding the female threads.

- REFERENCE SPECIFICATIONS :
1. BS 2779(BSPP)
 2. DIN-ISO 228/1
 3. JIS B0202
 4. ISO 228/1

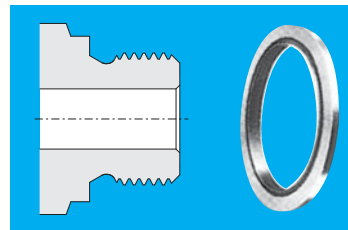

ISO Parallel with Bonded Washer Seal

No reverse angle is used. Instead, a self centering taper is used at hex to center a composite washer (usually metal and elastomer) to seal the surface surrounding the female thread.

ISO 7/1 tapered thread looks similar to NPT thread. However, ISO 7/1 has 55° thread angle while NPT has 60°, and ISO 7/1 pitch is measured in millimeters while NPT pitch is measured in inches. There are several different descriptions as listed on the right.

- REFERENCE SPECIFICATIONS :
1. BS 21 (BSPT)
 2. DIN-2999
 3. JIS B0203
 4. ISO 7/1

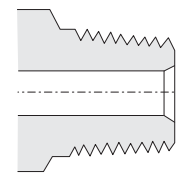

ISO Tapered (Thread Sealant Required)



Hy-Lok two ferrule tube fittings part numbers are easily understandable and basically composed of 3 groups as shown below.

Designator	First	Second	Third
Group	① ⑩	②	③
Example 1	CTA	-8	-BRAS
Example 2	CMC4	-4N	-S316
Exam 1	Union Tee	1/2" Hy-Lok	Brass
Exam 2	Male Connector With 1/4"Hy-Lok	1/4" NPT	316 Stainless steel

- The first group in example 1 or former part of first group in example 2 ① designates the fitting type.
- The second group in example 1 ② designates either Hy-Lok tube end size of unions, union tees, crosses, etc. Where all Hy-Lok tube end sizes are the same or size of plugs, caps, nuts, etc. where only single end exists.
- The latter part of first group in example 2 ⑩ designates the Hy-Lok tube end size and the second group ② designates pipe thread / size, or Hy-Lok tube end size, or tube size of fittings other than the fittings applicable to example 1.
- The third group designates the fitting material.
- In tees shown below, "2" is referred to as run and "3" is referred to as branch.

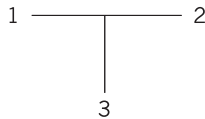

Material Designator			
Material	SS 316	Brass	Monel
Designator	S316	BRAS	MONL

Table 8. Fitting Type Designator

Identifier	Description	Identifier	Description
CUA	Union	CFU	AN Union
CUR	Reducing Union	CBFU	AN Bulkhead Union
CLA	Union Elbow	CFA	AN Adapter
CTA	Union Tee	CSC	SAE Male Connector
CXA	Union Cross	CSLA	Positionable Male Elbow
CBU	Bulkhead Union	CSRT	Positionable Male Run Tee
CMC	Male Connector	CSBT	Positionable Male Branch Tee
CMCT	Thermocouple Male Connector	CSLB	Positionable 45° Male Elbow
CMC-G	Male Connector For Bonded Seal	COS	O-Seal Straight Thread Connector
COM	Male Connector For Metal Seal	COP	O-Seal Pipe Thread Connector
CBMC	Bulkhead Male Connector	CWC	Male Pipe Weld Connector
CLMA	Male Elbow	CLW	Male Pipe Weld
CLMB	45° Male Elbow	CSWC	Tube Socket Weld Connector
CRTM	Male Run Tee	CLSW	Tube Socket Weld Elbow
CBTM	Male Branch Tee	CBUW	Weld Union
CFC	Female Connector	CHBUW	Weld Half Union
CGC	Gauge Connector	CPA	Plug
CBFC	Bulkhead Female Connector	CCA	Cap
CLF	Female Elbow	CRMTU	Union
CRTF	Female Run Tee	CRMTT	Union Tee
CBTF	Female Branch	CCEFF	Female Hy-Lok Union
CR	Reducer	CCEUR	Reducing Union
CBR	Bulkhead Reducer	CDF	Dielectric Fitting
CAL	Adjustable Elbow	CSFC	Sanitary Flange Fitting
CRTA	Adjustable Run Tee	CN	Nut
CBTA	Adjustable Branch Tee	CFF	Front Ferrule
CAM	Male Adapter	CFB	Back Ferrule
CAF	Female Adapter	CFS	Ferrule Set
CAM-G	Male Adapter	CNFS	Nut Ferrule Set
CAM-U	SAE / MS Male Adapter	CI	Tube Insert
CAMOS	O-Seal Straight Thread Male Adapter	CBRE	Bulkhead Retainer
CAMF	AN Adapter	CCL	Sure Ring
SAPW	Weld Adapter	CIG	Gap Gauge
CPC	Port Connector	CTDM	Tube Marker
CPR	Reducing Port Connector	CJ	Preswaging Tool
CFTC	Flange Lapped Tube Connector	CTW	Tee Wrench
CIAC	Integral ANSI Flange Connector	CTDT	Tube Deburring Tools
		EZY-MAT	Preswaging Tool

Tube End Designator

Fractional Tube	O.D.	1/16"	1/8"	3/16"	1/4"	5/16"	3/8"	1/2"	5/8"	3/4"	7/8"	1"	1 1/4"	1 1/2"	2"
Designator		1	2	3	4	5	6	8	10	12	14	16	20	24	32
Metric Tube	O.D.	2mm	3mm	4mm	6mm	8mm	10mm	12mm	16mm	20mm	22mm	25mm	28mm	32mm	38mm
Designator		2M	3M	4M	6M	8M	10M	12M	16M	20M	22M	25M	28M	32M	38M

Pipe Thread Designator





Nom. Size	1/8"	1/4"	3/8"	1/2"	3/4"	1"	1 1/4"	1 1/2"	2"	Applicable Specifications
ISO Tapered	2R	4R	6R	8R	12R	16R	20R	24R	32R	JIS B0203(PT), DIN2999, ISO7/1, BS 21(BSPT)
NPT	2N	4N	6N	8N	12N	16N	20N	24N	32N	ANSI B1.20.1 (NPT)
ISO Parallel	2G	4G	6G	8G	12G	16G	20G	24G	32G	JIS B0202(PF), DIN ISO 228/1, BS 2779(BSPP)
Unified Screw	2U	4U	6U	8U	12U	16U	20U	24U	32U	American Standard unified Screw Thread



Hy-Lok Two Ferrules Tube Fittings

Tube To Tube

- Union
CUA  **13**
- Reducing Union
CUR  **14**
- Union Elbow
CLA  **16**
- Union Tee
CTA  **17**
- Union Cross
CXA  **18**
- Bulkhead Union
CBU  **19**

Tube To Male Pipe

- Male Connector
CMC  **20**
- Thermocouple Connector
CMCT  **21**
- Male Connector For Bonded Washer Seal
CMC-G  **22**
- Male Connector For Metal Gasket Seal
COM  **23**
- Bulkhead Male Connector
CBMC  **24**

- Male Elbow
CLMA  **24**
- 45° Male Elbow
CLMB  **25**
- Male Run Tee
CRTM  **26**
- Male Branch Tee
CBTM  **27**

Tube To Female Pipe

- Female Connector
CFC  **28**
- Gauge Connector
CGC  **30**
- Bulkhead Female Connector
CBFC  **31**
- Female Elbow
CLF  **32**
- Female Run Tee
CRTF  **33**
- Female Branch Tee
CBTF  **34**

Stub Tube Connector

- Reducer
CR  **35**
- Bulkhead Reducer
CBR  **37**
- Adjustable Elbow
CAL  **38**
- Adjustable Run Tee
CRTA  **39**
- Adjustable Branch Tee
CBTA  **40**
- Male Adapter
CAM  **41**
- Female Adapter
CAF  **42**

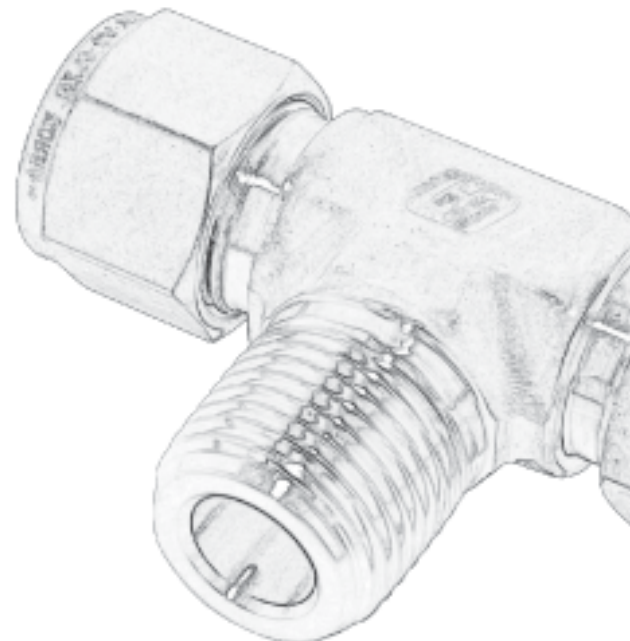



Male Adapter
CAM-G  43

SAE / MS Male Adapter
CAM-U  43

O-Seal Straight Thread Male Adapter
CAMOS  44

AN Adapter
CAMF  44

Weld Adapter
SAPW  44

Port Connector
CPC  45

Reducing Port Connector
CPR  45

Flange Connector

Flange Lapped Tube Connector
CFTC  46

Integral ANSI Flange Connector
CIAF  47

Tube To AN Tube

An Union
CFU  48

An Bulkhead Union
CBFU  48

An Adapter
CFA  48

Tube To SAE/MS O-Ring

SAE/MS Male Connector
CSC  51

Positionable Male Elbow
CSLA  51

Positionable Male Run Tee
CSRT  52

Positionable Male Branch Tee
CSBT  52

Positionable 45° Male Elbow
CSLB  53

O-Seal Straight Thread Connector
COS  53

O-Seal Pipe Thread Connector
COP  53

Tube To Weld End

Male Pipe Weld Connector
CWC  55

Male Pipe Weld Elbow
CLW  56

Tube Socket Weld Connector
CSWC  56

Tube Socket Weld Elbow
CLSW  56

Weld Union
CBUW  57

Weld Half Union
CHBUW  58

Plug and Cap

Plug
CPA  59

Cap
CCA  59







Tube To Tube

Union CRMTU		60
Union Tee CRMTT		60
Female Hy-Lok Union CCFF		61
Reducing Union CCEUR		61
Dielectric Fitting CDF		62

Tube To Kwik-Clamp Flanges

Sanitary Flange Fitting CSFC		63
--	---	----

Spare Parts

Nut CN		64
Front Ferrule CFF		64
Back Ferrule CFB		64
Ferrule Set CFS		65
Nut Ferrule Set CNFS		65
Tube Insert CI		66
Sure Ring CCL		66
Bulkhead Retainer CBRE		66

Tools

Gap Gauge CIG		67
Tube Mar CTDI		67
Preswagi CJ		68
Tee Wren CTW		68
Tube Deb CTD'		68
Preswagi EZY-I		69

Fusible Metal Fittings

Used to plug a female pipe port H-SPBFM		70
Used to plug a Tube Fittings CFTA		70
Used to Cap the End of a Tube CFSC		70
Used to Plug a Tube Fittings Port CFSP		70
Installation Instructions		71



Union
CUA

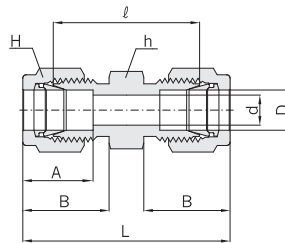

Connects Fractional Tubes

Part No.	Tube O.D. D		d Min.	Width across flat				A	B	ℓ	L
	in	mm		h		H					
				in	mm	in	mm				
CUA - 1	1/16	1.58	1.27	5/16	7.93	5/16	7.93	8.63	10.92	17.50	25.15
CUA - 2	1/8	3.17	2.28	7/16	11.11	7/16	11.11	12.70	15.24	22.35	35.56
CUA - 3	3/16	4.76	3.04	7/16	11.11	1/2	12.70	13.71	16.00	24.13	37.33
CUA - 4	1/4	6.35	4.82	1/2	12.70	9/16	14.28	15.24	17.78	26.16	40.89
CUA - 5	5/16	7.93	6.35	9/16	14.28	5/8	15.87	16.25	18.54	28.19	42.92
CUA - 6	3/8	9.52	7.11	5/8	15.87	11/16	17.46	16.76	19.30	30.22	44.95
CUA - 8	1/2	12.70	10.41	13/16	20.63	7/8	22.22	22.86	21.84	30.98	51.30
CUA - 10	5/8	15.87	12.70	15/16	23.81	1	25.40	24.38	21.84	31.75	52.07
CUA - 12	3/4	19.05	15.74	1-1/16	26.98	1-1/8	28.57	24.38	21.84	33.27	53.59
CUA - 14	7/8	22.22	18.28	1-3/16	30.16	1-1/4	31.75	25.90	21.84	35.05	55.37
CUA - 16	1	25.40	22.35	1-3/8	34.92	1-1/2	38.10	31.24	26.41	40.38	64.77
CUA - 20	1 1/4	31.75	27.68	1-3/4	44.45	1-7/8	47.62	41.14	38.86	48.00	92.20
CUA - 24	1 1/2	38.10	34.03	2-1/8	53.97	2-1/4	57.15	50.03	45.21	53.60	107.95
CUA - 32	2	50.80	45.97	2-3/4	69.85	3	76.20	67.56	62.73	74.70	149.35

Connects Metric Tubes

Part No.	Tube O.D. D	d Min.	Width across flat		A	B	ℓ	L
			h	H				
CUA - 2M	2	1.7	12	12	12.9	15.3	22.4	35.6
CUA - 3M	3	2.4	12	12	12.9	15.3	22.1	35.3
CUA - 4M	4	2.4	12	12	13.7	16.1	24.1	37.3
CUA - 6M	6	4.8	14	14	15.3	17.7	26.2	41.0
CUA - 8M	8	6.4	15	16	16.2	18.6	28.2	43.2
CUA - 10M	10	7.9	18	19	17.2	19.5	31.0	46.2
CUA - 12M	12	9.5	22	22	22.8	22.0	31.0	51.2
CUA - 15M	15	11.9	24	25	24.4	22.0	31.8	52.0
CUA - 16M	16	12.7	24	25	24.4	22.0	31.8	52.0
CUA - 18M	18	15.1	27	30	24.4	22.0	33.3	53.5
CUA - 20M	20	15.9	30	32	26.0	22.0	34.8	55.0
CUA - 22M	22	18.3	30	32	26.0	22.0	34.8	55.0
CUA - 25M	25	21.8	35	38	31.3	26.5	40.4	65.0
CUA - 28M	28	21.8	41	46	36.6	36.6	43.4	85.0
CUA - 32M	32	28.6	46	50	42.0	41.6	51.3	97.3
CUA - 38M	38	33.7	55	60	49.4	47.9	58.4	113.6
CUA - 42M	42	36.0	55	65	55.1	53.6	64.0	126.2

All dimensions are in millimeters unless otherwise specified. Dimensions are for reference only, subject to change.

Hy-Lok Two Ferrules Tube Fittings

Reducing Union CUR

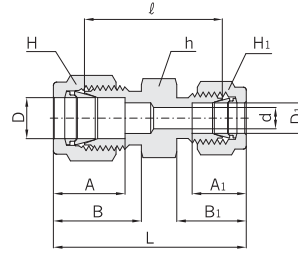

Connects Fractional Tubes

Part No.	Tube O.D.				d Min.	Width across flat						A	A ₁	B	B ₁	ℓ	L
	D		D ₁			h		H		H ₁							
	in	mm	in	mm		in	mm	in	mm	in	mm						
CUR 2- 1	1/8	3.17	1/16	1.58	1.27	7/16	11.11	7/16	11.11	5/16	7.93	12.70	8.63	15.24	10.92	20.60	30.91
CUR 3- 1	3/16	4.76	1/16	1.58	1.27	7/16	11.11	1/2	12.70	5/16	7.93	13.71	8.63	16.00	10.92	21.84	32.25
CUR 3- 2	3/16	4.76	1/8	3.17	2.28	7/16	11.11	1/2	12.70	7/16	11.11	13.71	12.70	16.00	15.24	23.36	36.57
CUR 4- 1	1/4	6.35	1/16	1.58	1.27	1/2	12.70	9/16	14.28	5/16	7.93	15.24	8.63	17.78	10.92	23.11	34.29
CUR 4- 2	1/4	6.35	1/8	3.17	2.28	1/2	12.70	9/16	14.28	7/16	11.11	15.24	12.70	17.78	15.24	24.63	38.60
CUR 4- 3	1/4	6.35	3/16	4.76	3.04	1/2	12.70	9/16	14.28	1/2	12.70	15.24	13.71	17.78	16.00	25.40	39.37
CUR 5- 2	5/16	7.93	1/8	3.17	2.28	9/16	14.28	5/8	15.87	7/16	11.11	16.25	12.70	18.54	15.24	25.90	39.87
CUR 5- 4	5/16	7.93	1/4	6.35	4.82	9/16	14.28	5/8	15.87	9/16	14.28	16.25	15.24	18.54	17.78	27.43	42.16
CUR 6- 1	3/8	9.52	1/16	1.58	1.27	5/8	15.87	11/16	17.46	5/16	7.93	16.76	8.63	19.30	10.92	25.40	36.57
CUR 6- 2	3/8	9.52	1/8	3.17	2.28	5/8	15.87	11/16	17.46	7/16	11.11	16.76	12.70	19.30	15.24	26.92	40.89
CUR 6- 4	3/8	9.52	1/4	6.35	4.82	5/8	15.87	11/16	17.46	9/16	14.28	16.76	15.24	19.30	17.78	28.44	43.18
CUR 6- 5	3/8	9.52	5/16	7.93	6.35	5/8	15.87	11/16	17.46	5/8	15.87	16.76	16.25	19.30	18.54	29.46	44.19
CUR 8- 2	1/2	12.70	1/8	3.17	2.28	13/16	20.63	7/8	22.22	7/16	11.11	22.86	12.70	21.84	15.24	28.44	45.21
CUR 8- 4	1/2	12.70	1/4	6.35	4.82	13/16	20.63	7/8	22.22	9/16	14.28	22.86	15.24	21.84	17.78	29.46	46.99
CUR 8- 6	1/2	12.70	3/8	9.52	7.11	13/16	20.63	7/8	22.22	11/16	17.46	22.86	16.76	21.84	19.30	30.98	48.51
CUR 10- 6	5/8	15.87	3/8	9.52	7.11	15/16	23.81	1	25.40	11/16	17.46	24.38	16.76	21.84	19.30	31.75	49.27
CUR 10- 8	5/8	15.87	1/2	12.70	10.41	15/16	23.81	1	25.40	7/8	22.22	24.38	22.86	21.84	21.84	31.75	52.07
CUR 12- 4	3/4	19.05	1/4	6.35	4.82	1-1/16	26.98	1-1/8	28.57	9/16	14.28	24.38	15.24	21.84	17.78	31.75	49.27
CUR 12- 6	3/4	19.05	3/8	9.52	7.11	1-1/16	26.98	1-1/8	28.57	11/16	17.46	24.38	16.76	21.84	19.30	33.27	50.80
CUR 12- 8	3/4	19.05	1/2	12.70	10.41	1-1/16	26.98	1-1/8	28.57	7/8	22.22	24.38	22.86	21.84	21.84	33.27	53.59
CUR 12-10	3/4	19.05	5/8	15.87	12.70	1-1/16	26.98	1-1/8	28.57	1	25.40	24.38	24.38	21.84	21.84	33.27	53.59
CUR 16- 8	1	25.40	1/2	12.70	10.41	1-3/8	34.92	1-1/2	38.10	7/8	22.22	31.24	22.86	26.41	21.84	40.89	63.24
CUR 16-12	1	25.40	3/4	19.05	15.74	1-3/8	34.92	1-1/2	38.10	1-1/8	28.57	31.24	24.38	26.41	21.84	40.38	62.73

Connects Metric Tubes

Part No.	Tube O.D.		d Min.	Width across flat			A	A ₁	B	B ₁	ℓ	L
	D	D ₁		h	H	H ₁						
CUR 3M - 2M	3	2	1.7	12	12	12	12.9	12.9	15.3	15.3	22.1	35.3
CUR 6M - 2M	6	2	1.7	14	14	12	15.3	12.9	17.7	15.3	24.6	38.6
CUR 6M - 3M	6	3	2.4	14	14	12	15.3	12.9	17.7	15.3	24.6	38.6
CUR 6M - 4M	6	4	2.4	14	14	12	15.3	13.7	17.7	16.1	25.4	39.4
CUR 8M - 6M	8	6	4.8	15	16	14	16.2	15.3	18.6	17.7	27.4	42.3
CUR 10M - 6M	10	6	4.8	18	19	14	17.2	15.3	19.5	17.7	29.5	44.5
CUR 10M - 8M	10	8	6.4	18	19	16	17.2	16.2	19.5	18.6	30.0	45.1
CUR 12M - 6M	12	6	4.8	22	22	14	22.8	15.3	22.0	17.7	29.5	47.0
CUR 12M - 8M	12	8	6.4	22	22	16	22.8	16.2	22.0	18.6	30.2	47.8
CUR 12M -10M	12	10	7.9	22	22	19	22.8	17.2	22.0	19.5	31.0	48.7
CUR 16M -10M	16	10	7.9	24	25	19	24.4	17.2	22.0	19.5	31.8	49.5
CUR 16M -12M	16	12	9.5	24	25	22	24.4	22.8	22.0	22.0	31.8	52.0
CUR 18M -12M	18	12	9.5	27	30	22	24.4	22.8	22.0	22.0	33.3	53.5
CUR 25M -18M	25	18	15.1	35	38	30	31.3	24.4	26.5	22.0	38.6	61.0
CUR 25M -20M	25	20	15.9	35	38	32	31.3	26.0	26.5	22.0	39.9	62.3

All dimensions are in millimeters unless otherwise specified. Dimensions are for reference only, subject to change.



Reducing Union
CUR

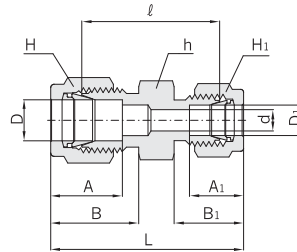

Connects Metric Tube To Fractional Tube

Part No.	Tube O.D.			d Min.	Width across flat			A	A ₁	B	B ₁	ℓ	L
	D	D ₁			h	H	H ₁						
		in	mm										
CUR 3M - 2	3	1/8	3.17	2.4	12.0	12	11.1	12.9	12.8	15.3	15.2	22.1	35.2
CUR 4M - 2	4	1/8	3.17	2.4	12.0	12	11.1	13.7	12.8	16.1	15.2	23.4	36.5
CUR 4M - 4	4	1/4	6.35	2.4	14.0	12	14.3	13.7	15.3	16.1	17.7	25.4	39.4
CUR 6M - 2	6	1/8	3.17	2.4	14.0	14	11.1	15.3	12.8	17.7	15.2	24.6	38.5
CUR 6M - 4	6	1/4	6.35	4.8	14.0	14	14.3	15.3	15.3	17.7	17.7	26.2	41.0
CUR 6M - 5	6	5/16	7.93	4.8	14.0	14	15.9	15.3	16.2	17.7	18.6	27.4	42.3
CUR 8M - 4	8	1/4	6.35	4.8	15.0	16	14.3	16.2	15.3	18.6	17.7	27.4	42.3
CUR 10M - 2	10	1/8	3.17	2.4	18.0	19	11.1	17.2	12.8	19.5	15.2	27.7	41.8
CUR 10M - 4	10	1/4	6.35	4.8	18.0	19	14.3	17.2	15.3	19.5	17.7	29.5	44.5
CUR 10M - 5	10	5/16	7.93	6.4	18.0	19	15.9	17.2	16.2	19.5	18.6	30.3	45.1
CUR 10M - 6	10	3/8	9.52	7.1	18.0	19	17.5	17.2	16.9	19.5	19.2	31.0	45.9
CUR 12M - 5	12	5/16	7.93	6.4	22.0	22	15.9	22.8	16.2	22.0	18.6	30.2	47.8
CUR 12M - 6	12	3/8	9.52	7.1	22.0	22	17.5	22.8	16.9	22.0	19.2	31.0	48.4
CUR 12M - 8	12	1/2	12.70	9.5	22.0	22	22.2	22.8	22.8	22.0	22.0	31.0	51.2
CUR 15M - 8	15	1/2	12.70	10.3	24.0	25	22.2	24.4	22.8	22.0	22.0	31.8	52.0
CUR 16M -10	16	5/8	15.87	12.7	24.0	25	25.4	24.4	24.4	22.0	22.0	31.8	52.0
CUR 18M -12	18	3/4	19.05	15.1	27.0	30	28.6	24.4	24.4	22.0	22.0	33.3	53.5
CUR 20M -12	20	3/4	19.05	15.9	30.0	32	28.6	26.0	24.4	22.0	22.0	34.8	54.9
CUR 20M -16	20	1	25.40	15.9	34.9	32	38.1	26.0	31.2	22.0	26.4	38.0	60.3
CUR 22M -16	22	1	25.40	15.9	34.9	32	38.1	26.0	31.2	22.0	26.4	38.2	60.3

All dimensions are in millimeters unless otherwise specified. Dimensions are for reference only, subject to change.

Hy-Lok Two Ferrules Tube Fittings

Union Elbow CLA

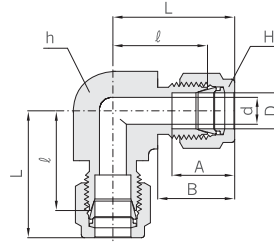

Connects Fractional Tubes

Part No.	Tube O.D. D		d Min.	Width across flat				A	B	ℓ	L
	in	mm		h		H					
				in	mm	in	mm				
CLA - 1	1/16	1.58	1.27	3/8	9.52	5/16	7.93	8.63	10.92	14.00	17.88
CLA - 2	1/8	3.17	2.28	3/8	9.52	7/16	11.11	12.70	15.24	15.74	22.35
CLA - 3	3/16	4.76	3.04	1/2	12.70	1/2	12.70	13.71	16.00	17.78	24.38
CLA - 4	1/4	6.35	4.82	1/2	12.70	9/16	14.28	15.24	17.78	19.55	26.92
CLA - 5	5/16	7.93	6.35	9/16	14.28	5/8	15.87	16.25	18.54	21.33	28.70
CLA - 6	3/8	9.52	7.11	5/8	15.87	11/16	17.46	16.76	19.30	23.11	30.48
CLA - 8	1/2	12.70	10.41	13/16	20.63	7/8	22.22	22.86	21.84	25.90	36.06
CLA -10	5/8	15.87	12.70	15/16	23.80	1	25.40	24.38	21.84	28.70	38.80
CLA -12	3/4	19.05	15.74	1-1/16	26.98	1-1/8	28.57	24.38	21.84	29.71	39.87
CLA -14	7/8	22.22	18.28	1-3/16	30.00	1-1/4	31.75	25.90	21.84	34.54	44.70
CLA -16	1	25.40	22.35	1-3/8	34.92	1-1/2	38.10	31.24	26.41	36.83	49.02
CLA -20	1-1/4	31.75	27.68	1-11/16	42.86	1-7/8	47.62	41.14	38.86	44.50	66.54
CLA -24	1-1/2	38.10	34.03	2	50.80	2-1/4	57.15	50.03	45.21	50.80	77.97
CLA -32	2	50.80	45.97	2-3/4	69.85	3	76.20	67.56	62.73	69.80	107.18

Connects Metric Tubes

Part No.	Tube O.D. D	d Min.	Width across flat		A	B	ℓ	L
			h	H				
CLA - 2M	2	1.7	9.5	12	12.9	15.3	15.7	22.3
CLA - 3M	3	2.4	9.5	12	12.9	15.3	15.7	22.3
CLA - 4M	4	2.4	12.7	12	13.7	16.4	18.8	25.4
CLA - 6M	6	4.8	12.7	14	15.3	17.7	19.6	27.0
CLA - 8M	8	6.4	14.3	16	16.2	18.6	21.3	28.8
CLA -10M	10	7.9	17.5	19	17.2	19.5	23.9	31.5
CLA -12M	12	9.5	20.6	22	22.8	22.0	25.9	36.0
CLA -15M	15	11.9	23.8	25	24.4	22.0	28.7	38.8
CLA -16M	16	12.7	23.8	25	24.4	22.0	28.7	38.8
CLA -18M	18	15.1	27.0	30	24.4	22.0	29.7	39.8
CLA -20M	20	15.9	30.0	32	26.0	22.0	32.5	42.6
CLA -22M	22	18.3	30.0	32	26.0	22.0	32.5	42.6
CLA -25M	25	21.8	34.9	38	31.3	26.5	36.8	49.1
CLA -28M	28	21.8	41.0	46	36.6	36.6	43.2	64.0
CLA -32M	32	28.6	46.0	50	42.0	41.6	49.3	72.3
CLA -38M	38	33.7	55.0	60	49.4	47.9	56.4	84.0
CLA -42M	42	36.0	55.0	65	55.1	53.6	58.0	89.1

All dimensions are in millimeters unless otherwise specified. Dimensions are for reference only, subject to change.



Union Tee
CTA

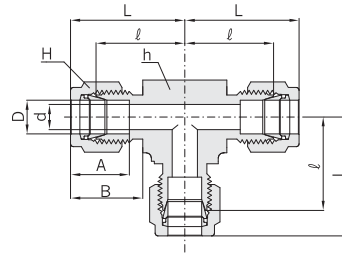

Connects Fractional Tubes

Part No.	Tube O.D. D		d Min.	Width across flat				A	B	ℓ	L
	in	mm		h		H					
				in	mm	in	mm				
CTA - 1	1/16	1.58	1.27	3/8	9.52	5/16	7.93	8.63	10.92	14.00	17.88
CTA - 2	1/8	3.17	2.28	3/8	9.52	7/16	11.11	12.70	15.24	15.74	22.35
CTA - 3	3/16	4.76	3.04	1/2	12.70	1/2	12.70	13.71	16.00	17.78	24.38
CTA - 4	1/4	6.35	4.82	1/2	12.70	9/16	14.28	15.24	17.78	19.55	26.92
CTA - 5	5/16	7.93	6.35	5/8	15.87	5/8	15.87	16.25	18.54	21.33	28.70
CTA - 6	3/8	9.52	7.11	5/8	15.87	11/16	17.46	16.76	19.30	23.11	30.48
CTA - 8	1/2	12.70	10.41	13/16	20.63	7/8	22.22	22.86	21.84	25.90	36.06
CTA -10	5/8	15.87	12.70	15/16	23.80	1	25.40	24.38	21.84	28.70	38.80
CTA -12	3/4	19.05	15.74	1-1/16	26.98	1-1/8	28.57	24.38	21.84	29.71	39.87
CTA -14	7/8	22.22	18.28	1-3/16	30.00	1-1/4	31.75	25.90	21.84	34.54	44.70
CTA -16	1	25.40	22.35	1-3/8	34.92	1-1/2	38.10	31.24	26.41	36.83	49.02
CTA -20	1-1/4	31.75	27.68	1-11/16	42.86	1-7/8	47.62	41.14	38.86	44.50	66.54
CTA -24	1-1/2	38.10	34.03	2	50.80	2-1/4	57.15	50.03	45.21	50.80	77.97
CTA -32	2	50.80	45.97	2-3/4	69.85	3	76.20	67.56	62.73	69.80	107.18

Connects Metric Tubes

Part No.	Tube O.D. D	d Min.	Width across flat		A	B	ℓ	L
			h	H				
CTA - 2M	2	1.7	9.5	12	12.9	15.3	15.7	22.3
CTA - 3M	3	2.4	9.5	12	12.9	15.3	15.7	22.3
CTA - 4M	4	2.4	12.7	12	13.7	16.1	18.8	25.4
CTA - 6M	6	4.8	12.7	14	15.3	17.7	19.6	27.0
CTA - 8M	8	6.4	14.3	16	16.2	18.6	21.3	28.8
CTA -10M	10	7.9	17.5	19	17.2	19.5	23.9	31.5
CTA -12M	12	9.5	20.6	22	22.8	22.0	25.9	36.0
CTA -15M	15	11.9	23.8	25	24.4	22.0	28.7	38.8
CTA -16M	16	12.7	23.8	25	24.4	22.0	28.7	38.8
CTA -18M	18	15.1	27.0	30	24.4	22.0	29.7	39.8
CTA -20M	20	15.9	30.0	32	26.0	22.0	32.5	42.6
CTA -22M	22	18.3	30.0	32	26.0	22.0	32.5	42.6
CTA -25M	25	21.8	34.9	38	31.3	26.5	36.8	49.1
CTA -28M	28	21.8	41.0	46	36.6	36.6	43.2	64.0
CTA -32M	32	28.6	46.0	50	42.0	41.6	49.3	72.3
CTA -38M	38	33.7	55.0	60	49.4	47.9	56.4	84.0
CTA -42M	42	36.0	55.0	65	55.1	53.6	58.0	89.1

*Reducing union tees are available upon request.

All dimensions are in millimeters unless otherwise specified. Dimensions are for reference only, subject to change.

Hy-Lok Two Ferrules Tube Fittings

Union Cross CXA

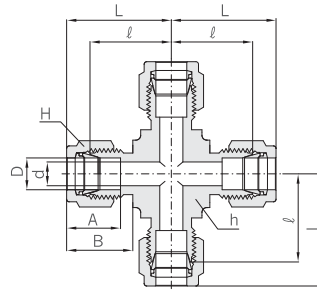

Connects Fractional Tubes

Part No.	Tube O.D. D		d Min.	Width across flat				A	B	ℓ	L
	in	mm		h		H					
				in	mm	in	mm				
CXA - 1	1/16	1.58	1.27	3/8	9.52	5/16	7.93	8.63	10.92	14.00	17.88
CXA - 2	1/8	3.17	2.28	3/8	9.52	7/16	11.11	12.70	15.24	15.74	22.35
CXA - 3	3/16	4.76	3.04	1/2	12.70	1/2	12.70	13.71	16.00	17.78	24.38
CXA - 4	1/4	6.35	4.82	1/2	12.70	9/16	14.28	15.24	17.78	19.55	26.92
CXA - 5	5/16	7.93	6.35	5/8	15.87	5/8	15.87	16.25	18.54	21.33	28.70
CXA - 6	3/8	9.52	7.11	5/8	15.87	11/16	17.46	16.76	19.30	23.11	30.48
CXA - 8	1/2	12.70	10.41	13/16	20.63	7/8	22.22	22.86	21.84	25.90	36.06
CXA-10	5/8	15.87	12.70	13/16	20.63	1	25.40	24.38	21.84	28.70	38.80
CXA-12	3/4	19.05	15.74	1-1/16	26.98	1-1/8	28.57	24.38	21.84	29.71	39.87
CXA-14	7/8	22.22	18.28	1-3/16	30.00	1-1/4	31.75	25.90	21.84	34.54	44.70
CXA-16	1	25.40	22.35	1-3/8	34.92	1-1/2	38.10	31.24	26.41	36.83	49.02

Connects Metric Tubes

Part No.	Tube O.D. D	d Min.	Width across flat		A	B	ℓ	L
			h	H				
CXA - 3M	3	2.4	9.5	12	12.9	15.3	15.7	22.3
CXA - 6M	6	4.8	12.7	14	15.3	17.7	19.6	27.0
CXA - 8M	8	6.4	15.8	16	16.2	18.6	21.3	28.8
CXA -10M	10	7.9	20.6	19	17.2	19.5	23.9	31.5
CXA -12M	12	9.5	20.6	22	22.8	22.0	25.9	36.0
CXA -16M	16	12.7	23.8	25	24.4	22.0	28.7	38.8
CXA -18M	18	15.1	27.0	30	24.4	22.0	29.7	39.8
CXA -20M	20	15.9	30.0	32	26.0	22.0	32.5	42.6
CXA -25M	25	21.8	34.9	38	31.3	22.0	36.8	49.1

All dimensions are in millimeters unless otherwise specified. Dimensions are for reference only, subject to change.



Bulkhead Union CBU

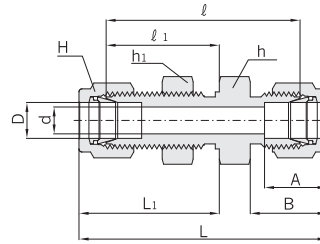

Connects Fractional Tubes

Part No.	Tube O.D. D		d Min.	Width across flat				A	B	l	l ₁	L	L ₁	Panel Hole Drill Size	Panel Max. Thickness
	in	mm		h, h ₁		H									
CBU - 1	1/16	1.58	1.27	5/16	7.93	5/16	7.93	8.63	10.92	23.87	13.46	31.50	17.27	5.16	3.05
CBU - 2	1/8	3.17	2.28	1/2	12.70	7/16	11.11	12.70	15.24	38.10	24.63	51.30	31.24	8.33	12.70
CBU - 3	3/16	4.76	3.04	9/16	14.28	1/2	12.70	13.71	16.00	40.38	25.40	53.59	32.00	9.92	12.70
CBU - 4	1/4	6.35	4.82	5/8	15.87	9/16	14.28	15.24	17.78	42.92	26.16	57.65	33.52	11.50	10.16
CBU - 5	5/16	7.93	6.35	11/16	17.46	5/8	15.87	16.25	18.54	45.97	28.44	60.70	35.81	13.09	11.17
CBU - 6	3/8	9.52	7.11	3/4	19.05	11/16	17.46	16.76	19.30	47.49	29.46	62.23	36.83	14.68	11.17
CBU - 8	1/2	12.70	10.41	15/16	23.81	7/8	22.22	22.86	21.84	50.80	31.75	71.12	41.91	19.44	12.70
CBU -10	5/8	15.87	12.70	1-1/16	26.98	1	25.40	24.38	21.84	52.32	32.51	72.64	42.67	22.62	12.70
CBU -12	3/4	19.05	15.74	1-3/16	30.16	1-1/8	28.57	24.38	21.84	58.67	37.33	78.99	47.49	25.79	16.76
CBU -14	7/8	22.22	18.28	1-3/8	34.92	1-1/4	31.75	25.90	21.84	64.26	42.92	84.58	53.08	28.97	19.05
CBU -16	1	25.40	22.35	1-5/8	41.27	1-1/2	38.10	31.24	26.41	71.37	45.21	95.75	57.40	33.73	19.05
CBU -20	1-1/4	31.75	27.68	1-7/8	47.62	1-7/8	47.62	41.14	38.86	78.99	47.75	123.19	69.85	41.67	19.05
CBU -24	1-1/2	38.10	34.03	2-1/4	57.15	2-1/4	57.15	50.03	45.21	84.83	49.27	139.19	76.45	49.61	19.05
CBU -32	2	50.80	45.97	2-3/4	69.85	3	76.20	67.56	62.73	105.66	56.38	180.34	93.72	67.07	19.05

Connects Metric Tubes

Part No.	Tube O.D. D	d Min.	Width across flat			A	B	l	l ₁	L	L ₁	Panel Hole Drill Size	Panel Max. Thickness
			h	h ₁ *	H								
CBU - 3M	3	2.4	14.0	12.7	12	12.9	15.3	38.1	24.6	51.3	31.2	8.3	12.7
CBU - 4M	4	2.4	14.0	14.3	12	13.7	16.1	40.4	25.4	53.6	32.0	9.9	12.7
CBU - 6M	6	4.8	16.0	15.9	14	15.3	17.7	42.9	26.2	57.7	33.6	11.5	10.2
CBU - 8M	8	6.4	18.0	17.5	16	16.2	18.6	46.0	28.6	61.0	36.1	13.1	11.2
CBU -10M	10	7.9	22.0	22.0	19	17.2	19.5	48.5	29.4	63.7	37.0	16.2	11.2
CBU -12M	12	9.5	24.0	23.8	22	22.8	22.0	50.8	31.8	71.0	41.9	19.5	12.7
CBU -15M	15	11.9	27.0	27.0	25	24.4	22.0	52.3	32.5	72.5	42.6	22.8	12.7
CBU -16M	16	12.7	27.0	27.0	25	24.4	22.0	52.3	32.5	72.5	42.6	22.8	12.7
CBU -18M	18	15.1	30.0	30.0	30	24.4	22.0	58.7	37.3	78.9	47.4	26.0	16.8
CBU -20M	20	15.9	35.0	35.0	32	26.0	22.0	64.3	42.9	84.5	53.0	29.0	17.0
CBU -22M	22	18.3	35.0	35.0	32	26.0	22.0	64.3	42.9	84.5	53.0	29.0	19.1
CBU -25M	25	21.8	41.3	41.3	38	31.3	26.5	71.4	45.2	95.9	57.5	33.7	19.1
CBU -32M	32	28.6	50.0	50.0	50	42.0	41.6	82.3	49.5	128.3	72.5	42.5	19.0
CBU -38M	38	33.7	60.0	60.0	60	49.4	47.9	89.4	51.5	144.6	79.1	50.5	19.0

*h₁ : Applicable to metric Tube bulkhead hexagon only.

All dimensions are in millimeters unless otherwise specified. Dimensions are for reference only, subject to change.

Hy-Lok Two Ferrules Tube Fittings

Male Connector CMC - N

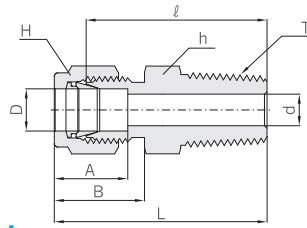

Connects Fractional Tube To Female NPT Thread

Part No.	Tube O.D. D		T* (NPT)	d Min.	Width across flat				A	B	l	L
	in	mm			h		H					
					in	mm	in	mm				
CMC 1 - 1N	1/16	1.58	1/16	1.27	5/16	7.93	5/16	7.93	8.63	10.92	20.00	23.83
CMC 1 - 2N	1/16	1.58	1/8	1.27	7/16	11.11	7/16	11.11	8.63	10.92	22.35	26.23
CMC 1 - 4N	1/16	1.58	1/4	1.27	9/16	14.28	5/16	7.93	8.63	10.92	27.17	30.98
CMC 2 - 1N	1/8	3.17	1/16	2.28	7/16	11.11	7/16	11.11	12.70	15.24	23.11	29.71
CMC 2 - 2N	1/8	3.17	1/8	2.28	7/16	11.11	7/16	11.11	12.70	15.24	23.87	30.48
CMC 2 - 4N	1/8	3.17	1/4	2.28	9/16	14.28	7/16	11.11	12.70	15.24	28.95	35.56
CMC 2 - 6N	1/8	3.17	3/8	2.28	11/16	17.46	7/16	11.11	12.70	15.24	29.21	35.81
CMC 2 - 8N	1/8	3.17	1/2	2.28	7/8	22.22	7/16	11.11	12.70	15.24	35.56	42.16
CMC 3 - 2N	3/16	4.76	1/8	3.04	7/16	11.11	1/2	12.70	13.71	16.00	24.63	31.24
CMC 3 - 4N	3/16	4.76	1/4	3.04	9/16	14.28	1/2	12.70	13.71	16.00	29.71	36.32
CMC 4 - 1N	1/4	6.35	1/16	4.82	1/2	12.70	9/16	14.28	15.24	17.78	25.40	32.76
CMC 4 - 2N	1/4	6.35	1/8	4.82	1/2	12.70	9/16	14.28	15.24	17.78	25.40	32.76
CMC 4 - 4N	1/4	6.35	1/4	4.82	9/16	14.28	9/16	14.28	15.24	17.78	30.48	37.84
CMC 4 - 6N	1/4	6.35	3/8	4.82	11/16	17.46	9/16	14.28	15.24	17.78	30.98	38.35
CMC 4 - 8N	1/4	6.35	1/2	4.82	7/8	22.22	9/16	14.28	15.24	17.78	37.33	44.70
CMC 4 - 12N	1/4	6.35	3/4	4.82	1-1/16	26.98	9/16	14.28	15.24	17.78	38.86	46.22
CMC 5 - 2N	5/16	7.93	1/8	4.82	9/16	14.28	5/8	15.87	16.25	18.54	26.67	34.03
CMC 5 - 4N	5/16	7.93	1/4	6.35	9/16	14.28	5/8	15.87	16.25	18.54	31.24	38.60
CMC 5 - 6N	5/16	7.93	3/8	6.35	11/16	17.46	5/8	15.87	16.25	18.54	31.75	39.11
CMC 6 - 2N	3/8	9.52	1/8	4.82	5/8	15.87	11/16	17.46	16.76	19.30	27.94	35.30
CMC 6 - 4N	3/8	9.52	1/4	7.11	5/8	15.87	11/16	17.46	16.76	19.30	32.51	39.87
CMC 6 - 6N	3/8	9.52	3/8	7.11	11/16	17.46	11/16	17.46	16.76	19.30	32.51	39.87
CMC 6 - 8N	3/8	9.52	1/2	7.11	7/8	22.22	11/16	17.46	16.76	19.30	38.86	46.22
CMC 6 - 12N	3/8	9.52	3/4	7.11	1-1/16	26.98	11/16	17.46	16.76	19.30	40.38	47.75
CMC 8 - 2N	1/2	12.70	1/8	4.82	13/16	20.63	7/8	22.22	22.86	21.84	28.70	38.86
CMC 8 - 4N	1/2	12.70	1/4	7.11	13/16	20.63	7/8	22.22	22.86	21.84	33.27	43.43
CMC 8 - 6N	1/2	12.70	3/8	9.65	13/16	20.63	7/8	22.22	22.86	21.84	33.27	43.43
CMC 8 - 8N	1/2	12.70	1/2	10.41	7/8	22.22	7/8	22.22	22.86	21.84	38.86	49.02
CMC 8 - 12N	1/2	12.70	3/4	10.41	1-1/16	26.98	7/8	22.22	22.86	21.84	40.38	50.54
CMC 8 - 16N	1/2	12.70	1	10.41	1-3/8	34.92	7/8	22.22	22.86	21.84	46.99	57.15
CMC 10 - 6N	5/8	15.87	3/8	9.65	15/16	23.81	1	25.40	24.38	21.84	34.03	44.19
CMC 10 - 8N	5/8	15.87	1/2	11.93	15/16	23.81	1	25.40	24.38	21.84	38.86	49.02
CMC 10 - 12N	5/8	15.87	3/4	12.70	1-1/16	26.98	1	25.40	24.38	21.84	40.38	50.54
CMC 12 - 8N	3/4	19.05	1/2	11.93	1-1/16	26.98	1-1/8	28.57	24.38	21.84	40.38	50.54
CMC 12 - 12N	3/4	19.05	3/4	15.74	1-1/16	26.98	1-1/8	28.57	24.38	21.84	40.38	50.54
CMC 12 - 16N	3/4	19.05	1	15.74	1-3/8	34.92	1-1/8	28.57	24.38	21.84	46.99	57.15
CMC 14 - 12N	7/8	22.22	3/4	15.74	1-3/16	30.16	1-1/4	31.75	25.90	21.84	40.38	50.54
CMC 14 - 16N	7/8	22.22	1	18.28	1-3/8	34.92	1-1/4	31.75	25.90	21.84	46.99	57.15
CMC 16 - 8N	1	25.40	1/2	11.93	1-3/8	34.92	1-1/2	38.10	31.24	26.41	45.21	57.40
CMC 16 - 12N	1	25.40	3/4	15.74	1-3/8	34.92	1-1/2	38.10	31.24	26.41	45.21	57.40
CMC 16 - 16N	1	25.40	1	22.35	1-3/8	34.92	1-1/2	38.10	31.24	26.41	50.03	62.23
CMC 20 - 16N	1-1/4	31.75	1	22.35	1-3/4	44.45	1-7/8	47.62	41.14	38.86	55.11	77.21
CMC 20 - 20N	1-1/4	31.75	1-1/4	27.68	1-3/4	44.45	1-7/8	47.62	41.14	38.86	55.11	77.21
CMC 24 - 24N	1-1/2	38.10	1-1/2	34.03	2-1/8	53.97	2-1/4	57.15	50.03	45.21	61.72	88.90
CMC 32 - 32N	2	50.80	2	45.97	2-3/4	69.85	3	76.20	67.56	62.73	76.20	113.53

* ISO Tapered Threads are available upon request.

All dimensions are in millimeters unless otherwise specified. Dimensions are for reference only, subject to change.

Tube To Male Pipe

Male Connector CMC - R

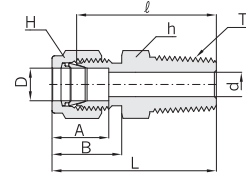

Connects Metric Tube To Female ISO Tapered Thread

Part No.	Tube O.D. D	T* R(PT)	d Min	Width across flat		A	B	ℓ	L
				h	H				
CMC 2M - 2R	2	1/8	1.7	12	12	12.9	15.3	23.9	30.5
CMC 3M - 2R	3	1/8	2.4	12	12	12.9	15.3	23.9	30.5
CMC 3M - 4R	3	1/4	2.4	14	12	12.9	15.3	29.0	35.6
CMC 4M - 2R	4	1/8	2.4	12	12	13.7	16.1	24.6	31.2
CMC 4M - 4R	4	1/4	2.4	14	12	13.7	16.1	29.7	36.3
CMC 6M - 2R	6	1/8	4.8	14	14	15.3	17.7	25.4	32.8
CMC 6M - 4R	6	1/4	4.8	14	14	15.3	17.7	30.5	37.9
CMC 6M - 6R	6	3/8	4.8	18	14	15.3	17.7	31.0	38.4
CMC 6M - 8R	6	1/2	4.8	22	14	15.3	17.7	37.3	44.7
CMC 8M - 2R	8	1/8	4.8	15	16	16.2	18.6	26.7	34.2
CMC 8M - 4R	8	1/4	6.4	15	16	16.2	18.6	31.2	38.7
CMC 8M - 6R	8	3/8	6.4	18	16	16.2	18.6	31.8	39.2
CMC 8M - 8R	8	1/2	6.4	22	16	16.2	18.6	38.1	45.6
CMC 10M - 2R	10	1/8	4.8	18	19	17.2	19.5	28.7	36.3
CMC 10M - 4R	10	1/4	7.1	18	19	17.2	19.5	33.3	40.9
CMC 10M - 6R	10	3/8	7.9	18	19	17.2	19.5	33.3	40.9
CMC 10M - 8R	10	1/2	7.9	22	19	17.2	19.5	38.9	46.5
CMC 12M - 4R	12	1/4	7.1	22	22	22.8	22.0	33.3	43.4
CMC 12M - 6R	12	3/8	9.5	22	22	22.8	22.0	33.3	43.4
CMC 12M - 8R	12	1/2	9.5	22	22	22.8	22.0	38.9	49.0
CMC 12M - 12R	12	3/4	9.5	27	22	22.8	22.0	40.4	50.5
CMC 15M - 8R	15	1/2	11.9	24	25	24.4	22.0	38.9	49.0
CMC 16M - 4R	16	1/4	7.1	24	25	24.4	22.0	34.0	44.1
CMC 16M - 6R	16	3/8	9.5	24	25	24.4	22.0	34.0	44.1
CMC 16M - 8R	16	1/2	11.9	24	25	24.4	22.0	38.9	49.0
CMC 16M - 12R	16	3/4	12.7	27	25	24.4	22.0	38.9	49.0
CMC 18M - 8R	18	1/2	11.9	27	30	24.4	22.0	40.4	50.5
CMC 18M - 12R	18	3/4	15.1	27	30	24.4	22.0	40.4	50.5
CMC 20M - 8R	20	1/2	11.9	30	32	26.0	22.0	42.2	52.3
CMC 20M - 12R	20	3/4	15.9	30	32	26.0	22.0	42.2	52.3
CMC 22M - 12R	22	3/4	15.9	30	32	26.0	22.0	42.2	52.3
CMC 22M - 16R	22	1	18.3	35	32	26.0	22.0	47.0	57.0
CMC 25M - 12R	25	3/4	15.9	35	38	31.3	26.5	45.2	57.5
CMC 25M - 16R	25	1	21.8	35	38	31.3	26.5	50.0	62.3
CMC 28M - 16R	28	1	21.8	41	46	36.6	36.6	51.6	72.4
CMC 28M - 20R	28	1-1/4	21.8	46	46	36.6	36.6	52.3	73.1
CMC 32M - 20R	32	1-1/4	28.6	46	50	42.0	41.6	56.6	79.6
CMC 32M - 24R	38	1-1/2	33.7	55	60	49.4	47.9	64.0	91.6

* NPT Threads are available upon request.

Thermocouple Male Connector CMCT



Bore-through male connectors handle thermocouples or dip tubes with ease.
For correct part number, just add "T" as a suffix to CMC, the male connector designator.
Example : CMCT 12M-8R-S316 12mm tube O.D. x 1/2" ISO tapered stainless Steel 316
 CMCT 8-8N-S316 1/2" tube O.D. x 1/2" NPT stainless steel 316

Note : There are some limitations in size available as it is impractical to bore through all male connectors.
For availability, contact your local distributor.

All dimensions are in millimeters unless otherwise specified. Dimensions are for reference only, subject to change.

Hy-Lok Two Ferrules Tube Fittings

Male Connector For Bonded Washer Seal

CMC - G

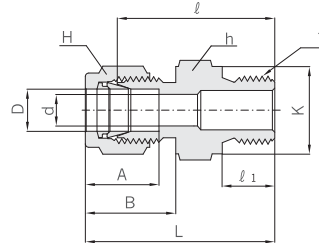

Connects Metric Tube To Female ISO Parallel Thread

Part No.	Tube O.D. D	T G(PF)	d Min.	Width across flat		A	B	l	l ₁	L	K
				h	H						
CMC 2M - 2G	2	1/8	1.7	14	12	12.9	15.3	23.4	7.1	30.0	13.8
CMC 3M - 2G	3	1/8	2.4	14	12	12.9	15.3	23.4	7.1	30.0	13.8
CMC 3M - 4G	3	1/4	2.4	19	12	12.9	15.3	28.7	11.2	35.3	18.0
CMC 4M - 2G	4	1/8	2.4	14	12	13.7	16.1	24.1	7.1	30.7	13.8
CMC 6M - 2G	6	1/8	4.0	14	14	15.3	17.7	24.9	7.1	32.3	13.8
CMC 6M - 4G	6	1/4	4.8	19	14	15.3	17.7	30.2	11.2	37.6	18.0
CMC 6M - 6G	6	3/8	4.8	22	14	15.3	17.7	31.5	11.2	38.9	21.8
CMC 6M - 8G	6	1/2	4.8	27	14	15.3	17.7	37.3	14.2	44.7	26.0
CMC 8M - 2G	8	1/8	4.0	15	16	16.2	18.6	25.7	7.1	33.2	13.8
CMC 8M - 4G	8	1/4	6.4	19	16	16.2	18.6	31.0	11.2	38.5	13.8
CMC 8M - 6G	8	3/8	6.4	22	16	16.2	18.6	32.3	11.2	39.8	21.8
CMC 8M - 8G	8	1/2	6.4	27	16	16.2	18.6	38.1	14.2	45.6	26.0
CMC 10M - 4G	10	1/4	5.8	19	19	17.2	19.5	31.8	11.2	39.4	18.0
CMC 10M - 6G	10	3/8	7.9	22	19	17.2	19.5	33.0	11.2	40.6	21.8
CMC 10M - 8G	10	1/2	7.9	27	19	17.2	19.5	38.9	14.2	46.5	26.0
CMC 12M - 4G	12	1/4	5.8	22	22	22.8	22.0	32.5	11.2	42.6	18.0
CMC 12M - 6G	12	3/8	7.9	22	22	22.8	22.0	33.0	11.2	43.1	21.8
CMC 12M - 8G	12	1/2	9.5	27	22	22.8	22.0	38.9	14.2	49.0	26.0
CMC 12M - 12G	12	3/4	9.5	32	22	22.8	22.0	42.7	15.7	52.8	32.0
CMC 16M - 6G	16	3/8	7.9	24	25	24.4	22.0	33.8	11.2	43.9	21.8
CMC 16M - 8G	16	1/2	11.9	27	25	24.4	22.0	38.9	14.2	49.0	26.0
CMC 18M - 8G	18	1/2	11.9	27	30	24.4	22.0	38.9	14.2	49.0	26.0
CMC 18M - 12G	18	3/4	15.1	32	30	24.4	22.0	42.7	15.7	52.8	32.0
CMC 20M - 8G	20	1/2	11.9	30	32	26.0	22.0	40.4	14.2	50.5	26.0
CMC 20M - 12G	20	3/4	15.9	32	32	26.0	22.0	42.7	15.7	52.8	32.0
CMC 22M - 12G	22	3/4	15.9	32	32	26.0	22.0	42.7	15.7	52.8	32.0
CMC 22M - 16G	22	1	18.3	41	32	26.0	22.0	45.2	18.3	55.3	39.0
CMC 25M - 12G	25	3/4	15.9	35	38	31.3	26.5	45.2	15.7	57.5	32.0
CMC 25M - 16G	25	1	19.8	41	38	31.3	26.5	47.8	18.3	60.1	39.0
CMC 28M - 16G	28	1	19.8	41	46	36.6	36.6	49.3	18.3	70.1	39.0
CMC 28M - 20G	28	1-1/4	21.8	50	46	36.6	36.6	53.1	19.8	73.9	49.0
CMC 32M - 20G	32	1-1/4	25.0	50	50	42.0	41.6	55.9	19.8	78.9	49.0
CMC 38M - 24G	38	1-1/2	31.8	55	60	49.4	47.9	63.2	22.1	90.8	54.7

For leak tight installation, see ISO Parallel and Tapered Pipe Thread on page 7.

All dimensions are in millimeters unless otherwise specified. Dimensions are for reference only, subject to change.



Male Connector For Metal Gasket Seal
COM

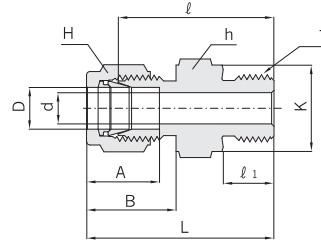

Connects Metric Tube To Female ISO Parallel Thread

Part No.	Tube O.D. D	T G(PF)	d Min.	Width across flat		A	B	l	l ₁	L	K
				h	H						
COM 3M - 2G	3	1/8	2.4	14	12	12.9	15.3	23.4	7.1	30.0	13.8
COM 3M - 4G	3	1/4	2.4	19	12	12.9	15.3	28.7	11.2	35.3	18.0
COM 4M - 2G	4	1/8	2.4	14	12	13.7	16.1	24.1	7.1	30.7	13.8
COM 6M - 2G	6	1/8	4.0	14	14	15.3	17.7	24.9	7.1	32.3	13.8
COM 6M - 4G	6	1/4	4.8	19	14	15.3	17.7	30.2	11.2	37.6	18.0
COM 6M - 6G	6	3/8	4.8	22	14	15.3	17.7	31.5	11.2	38.9	21.8
COM 6M - 8G	6	1/2	4.8	27	14	15.3	17.7	37.3	14.2	44.7	26.0
COM 8M - 2G	8	1/8	4.0	15	16	16.2	18.6	25.7	7.1	33.2	13.8
COM 8M - 4G	8	1/4	6.4	19	16	16.2	18.6	31.0	11.2	38.5	18.0
COM 8M - 6G	8	3/8	6.4	22	16	16.2	18.6	32.3	11.2	39.8	21.8
COM 8M - 8G	8	1/2	6.4	27	16	16.2	18.6	38.1	14.2	45.6	26.0
COM 10M - 4G	10	1/4	5.8	19	19	17.2	19.5	31.8	11.2	39.4	18.0
COM 10M - 6G	10	3/8	7.9	22	19	17.2	19.5	33.0	11.2	40.6	21.8
COM 10M - 8G	10	1/2	7.9	27	19	17.2	19.5	38.9	14.2	46.5	26.0
COM 12M - 4G	12	1/4	5.8	22	22	22.8	22.0	32.5	11.2	42.6	18.0
COM 12M - 6G	12	3/8	7.9	22	22	22.8	22.0	33.0	11.2	43.1	21.8
COM 12M - 8G	12	1/2	9.5	27	22	22.8	22.0	38.9	14.2	49.0	26.0
COM 12M - 12G	12	3/4	9.5	32	22	22.8	22.0	42.7	15.7	52.8	32.0
COM 15M - 8G	15	1/2	11.9	27	25	24.4	22.0	38.9	14.2	49.0	26.0
COM 16M - 6G	16	3/8	7.9	24	25	24.4	22.0	33.8	11.2	43.9	21.8
COM 16M - 8G	16	1/2	11.9	27	25	24.4	22.0	38.9	14.2	49.0	26.0
COM 18M - 8G	18	1/2	11.9	27	30	24.4	22.0	38.9	14.2	49.0	26.0
COM 18M - 12G	18	3/4	15.1	32	30	24.4	22.0	42.7	15.7	52.8	32.0
COM 20M - 8G	20	1/2	11.9	30	32	26.0	22.0	40.4	14.2	50.5	26.0
COM 20M - 12G	20	3/4	15.9	32	32	26.0	22.0	42.7	15.7	52.8	32.0
COM 22M - 12G	22	3/4	15.9	32	32	26.0	22.0	42.7	15.7	52.8	32.0
COM 22M - 16G	22	1	18.3	41	32	26.0	22.0	45.2	18.3	55.3	39.0
COM 25M - 12G	25	3/4	15.9	35	38	31.3	26.5	45.2	15.7	57.5	32.0
COM 25M - 16G	25	1	19.8	41	38	31.3	26.5	47.8	18.3	60.1	39.0
COM 28M - 16G	28	1	19.8	41	46	36.6	36.6	49.3	18.3	70.1	39.0
COM 28M - 20G	28	1-1/4	21.8	50	46	36.6	36.6	53.1	19.8	73.9	49.0
COM 32M - 20G	32	1-1/4	28.6	50	50	42.0	41.6	55.9	19.8	78.9	49.0
COM 38M - 24G	38	1-1/2	31.8	55	60	49.4	47.9	61.7	20.6	89.3	54.7

For leak tight installation, see ISO Parallel and Tapered Pipe Thread on page 7.

Hy-Lok Two Ferrules Tube Fittings

Bulkhead Male Connector CBMC

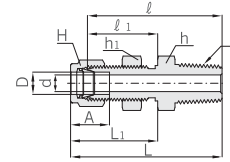

Connects Fractional Tube To Female NPT Thread

Part No.	Tube O.D. D		T* (NPT)	d Min.	Width across flat						A	ℓ	ℓ ₁	L	L ₁	Panel Hole Drill Size	Panel Max. Thickness
	in	mm			h		h ₁		H								
					in	mm	in	mm	in	mm							
CBMC 2 - 2N	1/8	3.17	1/8	2.28	1/2	12.70	1/2	12.70	7/16	11.11	12.70	39.87	24.63	46.48	31.24	8.33	12.20
CBMC 4 - 2N	1/4	6.35	1/8	4.82	5/8	15.87	5/8	15.87	9/16	14.28	15.24	42.16	26.16	49.53	33.52	11.50	10.16
CBMC 4 - 4N	1/4	6.35	1/4	4.82	5/8	15.87	5/8	15.87	9/16	14.28	15.24	45.97	26.16	53.34	33.52	11.50	10.16
CBMC 6 - 4N	3/8	9.52	1/4	7.11	3/4	19.05	3/4	19.05	11/16	17.46	16.76	50.03	29.46	57.40	36.83	14.68	11.17
CBMC 6 - 6N	3/8	9.52	3/8	7.11	3/4	19.05	3/4	19.05	11/16	17.46	16.76	50.03	29.46	57.40	36.83	14.68	11.17
CBMC 6 - 8N	3/8	9.52	1/2	7.11	7/8	22.22	3/4	19.05	11/16	17.46	16.76	56.38	29.46	63.75	36.83	14.68	11.17
CBMC 8 - 6N	1/2	12.70	3/8	9.39	15/16	23.81	15/16	23.81	7/8	22.22	22.86	53.08	31.75	63.24	41.91	19.44	12.70
CBMC 8 - 8N	1/2	12.70	1/2	10.41	15/16	23.81	15/16	23.81	7/8	22.22	22.86	58.67	31.75	68.83	41.91	19.44	12.70
CBMC12-12N	3/4	19.05	3/4	15.74	1-3/16	30.16	1-3/16	30.16	1-1/8	28.57	24.38	66.04	37.33	76.20	47.49	25.76	16.76
CBMC16-16N	1	25.40	1	22.35	1-5/8	41.27	1-5/8	41.27	1-1/2	38.10	31.24	81.02	45.21	93.21	57.40	33.73	19.05

Male Elbow CLMA

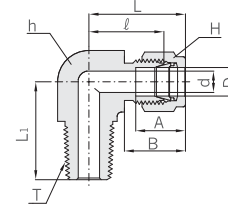

Connects Fractional Tube To Female NPT Thread

Part No.	Tube O.D. D		T* (NPT)	d Min.	Width across flat				A	B	ℓ	L	L ₁
	in	mm			h		H						
					in	mm	in	mm					
CLMA 1 - 1N	1/16	1.58	1/16	1.27	7/16	11.11	5/16	7.93	8.63	10.92	15.24	19.05	17.78
CLMA 1 - 2N	1/16	1.58	1/8	1.27	7/16	11.11	5/16	7.93	8.63	10.92	15.24	19.05	17.78
CLMA 2 - 2N	1/8	3.17	1/8	2.28	1/2	12.70	7/16	11.11	12.70	15.24	18.30	24.91	18.90
CLMA 2 - 4N	1/8	3.17	1/4	2.28	1/2	12.70	7/16	11.11	12.70	15.24	18.30	24.91	23.36
CLMA 3 - 2N	3/16	4.76	1/8	3.04	1/2	12.70	1/2	12.70	13.71	16.00	18.79	25.40	18.79
CLMA 3 - 4N	3/16	4.76	1/4	3.04	1/2	12.70	1/2	12.70	13.71	16.00	18.79	25.40	23.36
CLMA 4 - 1N	1/4	6.35	1/16	3.04	1/2	12.70	9/16	14.28	15.24	17.78	19.55	26.90	18.79
CLMA 4 - 2N	1/4	6.35	1/8	4.82	1/2	12.70	9/16	14.28	15.24	17.78	19.10	26.47	19.10
CLMA 4 - 4N	1/4	6.35	1/4	4.82	1/2	12.70	9/16	14.28	15.24	17.78	19.81	27.18	23.87
CLMA 4 - 6N	1/4	6.35	3/8	4.82	11/16	17.46	9/16	14.28	15.24	17.78	22.35	29.71	28.40
CLMA 4 - 8N	1/4	6.35	1/2	4.82	13/16	20.63	9/16	14.28	15.24	17.78	24.60	31.97	33.00
CLMA 5 - 2N	5/16	7.93	1/8	4.82	9/16	14.28	5/8	15.87	16.25	18.54	21.33	28.70	19.81
CLMA 5 - 4N	5/16	7.93	1/4	6.35	9/16	14.28	5/8	15.87	16.25	18.54	22.40	29.77	24.50
CLMA 5 - 6N	5/16	7.93	3/8	6.35	11/16	17.46	5/8	15.87	16.25	18.54	23.11	30.48	28.40
CLMA 6 - 2N	3/8	9.52	1/8	4.82	5/8	15.87	11/16	17.46	16.76	19.30	23.11	30.48	20.80
CLMA 6 - 4N	3/8	9.52	1/4	7.11	5/8	15.87	11/16	17.46	16.76	19.30	23.11	30.48	25.40
CLMA 6 - 6N	3/8	9.52	3/8	7.11	11/16	17.46	11/16	17.46	16.76	19.30	23.87	31.24	28.44
CLMA 6 - 8N	3/8	9.52	1/2	7.11	13/16	20.63	11/16	17.46	16.76	19.30	23.80	31.42	33.02
CLMA 6 - 12N	3/8	9.52	3/4	7.11	1-1/16	26.98	11/16	17.46	16.76	19.30	29.71	37.08	36.83
CLMA 8 - 4N	1/2	12.70	1/4	7.11	13/16	20.63	7/8	22.22	22.86	21.84	25.90	36.06	28.30
CLMA 8 - 6N	1/2	12.70	3/8	9.65	13/16	20.63	7/8	22.22	22.86	21.84	25.90	36.06	28.30
CLMA 8 - 8N	1/2	12.70	1/2	10.41	13/16	20.63	7/8	22.22	22.86	21.84	25.90	36.06	33.02
CLMA 8 - 12N	1/2	12.70	3/4	10.41	1-1/16	26.98	7/8	22.22	22.86	21.84	29.71	39.87	36.83
CLMA10 - 6N	5/8	15.87	3/8	9.65	15/16	23.80	1	25.40	24.38	21.84	27.90	37.06	30.20
CLMA10 - 8N	5/8	15.87	1/2	11.93	15/16	23.80	1	25.40	24.38	21.84	27.90	37.06	35.00
CLMA10 - 12N	5/8	15.87	3/4	12.70	1-1/16	26.98	1	25.40	24.38	21.84	29.71	39.87	36.83
CLMA12 - 8N	3/4	19.05	1/2	11.93	1-1/16	26.98	1-1/8	28.57	24.38	21.84	29.71	39.87	36.83
CLMA12 - 12N	3/4	19.05	3/4	15.74	1-1/16	26.98	1-1/8	28.57	24.38	21.84	29.71	39.87	36.83
CLMA14 - 12N	7/8	22.22	3/4	15.74	1-3/16	30.00	1-1/4	31.75	25.90	21.84	34.54	44.70	41.65
CLMA16 - 12N	1	25.40	3/4	15.74	1-3/8	34.92	1-1/2	38.10	31.24	26.41	36.83	49.02	42.20
CLMA16 - 16N	1	25.40	1	22.35	1-3/8	34.92	1-1/2	38.10	31.24	26.41	36.83	49.02	46.70
CLMA20 - 20N	1-1/4	31.75	1-1/4	27.68	1-11/16	42.86	1-7/8	47.62	41.14	38.86	44.50	66.54	47.75
CLMA24 - 24N	1-1/2	38.10	1-1/2	34.03	2	50.80	2-1/4	57.15	50.03	45.21	50.80	77.97	60.45
CLMA32 - 32N	2	50.80	2	45.97	2-3/4	69.85	3	76.20	67.56	62.73	69.80	107.18	70.61

*ISO Tapered Threads are available upon request.

All dimensions are in millimeters unless otherwise specified. Dimensions are for reference only, subject to change.



Male Elbow
CLMA

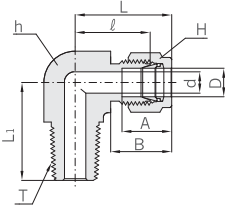

Connects Metric Tube To Female ISO Tapered Thread

Part No.	Tube O.D. D	T* R(PT)	d Min.	Width across flat		A	B	ℓ	L	L ₁
				h	H					
CLMA 3M - 2R	3	1/8	2.4	12.7	12	12.9	15.3	17.0	23.6	17.8
CLMA 3M - 4R	3	1/4	2.4	12.7	12	12.9	15.3	18.0	24.6	23.4
CLMA 4M - 2R	4	1/8	2.4	12.7	12	13.7	16.1	18.8	25.4	18.8
CLMA 4M - 4R	4	1/4	2.4	12.7	12	13.7	16.1	18.8	25.4	23.4
CLMA 6M - 2R	6	1/8	4.8	12.7	14	15.3	17.7	19.6	27.0	18.8
CLMA 6M - 4R	6	1/4	4.8	12.7	14	15.3	17.7	19.6	27.0	23.4
CLMA 6M - 6R	6	3/8	4.8	17.5	14	15.3	17.7	22.4	29.8	26.2
CLMA 6M - 8R	6	1/2	4.8	20.6	14	15.3	17.7	24.4	31.8	33.0
CLMA 8M - 2R	8	1/8	4.8	14.3	16	16.2	18.6	21.3	28.8	19.8
CLMA 8M - 4R	8	1/4	6.4	14.3	16	16.2	18.6	21.3	28.8	24.4
CLMA 8M - 6R	8	3/8	6.4	17.5	16	16.2	18.6	23.9	31.4	28.5
CLMA 8M - 8R	8	1/2	6.4	20.6	16	16.2	18.6	25.1	32.6	33.0
CLMA10M - 2R	10	1/8	4.8	17.5	19	17.2	19.5	23.9	31.5	23.6
CLMA10M - 4R	10	1/4	7.1	17.5	19	17.2	19.5	23.9	31.5	26.2
CLMA10M - 6R	10	3/8	7.9	17.5	19	17.2	19.5	23.9	31.5	26.2
CLMA10M - 8R	10	1/2	7.9	20.6	19	17.2	19.5	25.9	33.5	33.0
CLMA12M - 2R	12	1/8	4.8	20.6	22	22.8	22.0	25.9	36.0	23.6
CLMA12M - 4R	12	1/4	7.1	20.6	22	22.8	22.0	25.9	36.0	26.2
CLMA12M - 6R	12	3/8	9.5	20.6	22	22.8	22.0	25.9	36.0	26.2
CLMA12M - 8R	12	1/2	9.5	20.6	22	22.8	22.0	25.9	36.0	33.0
CLMA12M -12R	12	3/4	9.5	27.0	22	22.8	22.0	29.7	39.8	36.8
CLMA16M - 6R	16	3/8	9.5	23.8	25	24.4	22.0	27.9	38.0	30.2
CLMA16M - 8R	16	1/2	11.9	23.8	25	24.4	22.0	27.9	38.0	35.1
CLMA16M -12R	16	3/4	12.7	27.0	25	24.4	22.0	29.7	39.8	36.8
CLMA18M - 8R	18	1/2	11.9	27.0	30	24.4	22.0	29.7	39.8	36.8
CLMA18M -12R	18	3/4	15.1	27.0	30	24.4	22.0	29.7	39.8	36.8
CLMA20M - 8R	20	1/2	11.9	34.9	32	26.0	22.0	34.5	44.6	41.7
CLMA20M -12R	20	3/4	15.9	30.0	32	26.0	22.0	34.5	44.6	41.7
CLMA22M -12R	22	3/4	15.9	30.0	32	26.0	22.0	34.5	44.6	41.7
CLMA22M -16R	22	1	18.3	34.9	32	26.0	22.0	34.5	44.6	46.5
CLMA25M -12R	25	3/4	15.9	34.9	38	31.3	26.5	36.8	49.1	41.7
CLMA25M -16R	25	1	21.8	34.9	38	31.3	26.5	36.8	49.1	46.5

* NPT Threads are available upon request.

45° Male Elbow
CLMB

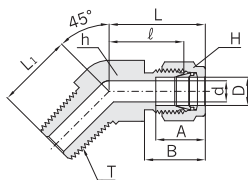

Connects Fractional Tube To Female NPT Thread

Part No.	Tube O.D. D		T* (NPT)	d Min.	Width across flat				A	B	ℓ	L	L ₁
	in	mm			h		H						
					in	mm	in	mm					
CLMB 4 - 2N	1/4	6.35	1/8	4.82	1/2	12.70	9/16	14.28	15.24	17.78	17.27	24.63	16.51
CLMB 4 - 4N	1/4	6.35	1/4	4.82	1/2	12.70	9/16	14.28	15.24	17.78	17.27	24.63	21.08
CLMB 6 - 2N	3/8	9.52	1/8	4.82	5/8	15.87	11/16	17.46	16.76	19.30	20.57	27.94	18.28
CLMB 6 - 4N	3/8	9.52	1/4	7.11	5/8	15.87	11/16	17.46	16.76	19.30	20.57	27.94	22.86
CLMB 6 - 6N	3/8	9.52	3/8	7.11	13/16	20.63	11/16	17.46	16.76	19.30	21.84	29.21	24.13
CLMB 8 - 6N	1/2	12.70	3/8	9.65	13/16	20.63	7/8	22.22	22.86	21.84	21.84	32.00	24.13
CLMB 8 - 8N	1/2	12.70	1/2	10.41	13/16	20.63	7/8	22.22	22.86	21.84	21.84	32.00	28.95
CLMB12-12N	3/4	19.05	3/4	15.74	1-1/8	28.57	1-1/8	28.57	24.38	21.84	23.87	34.03	30.98
CLMB16-16N	1	25.40	1	22.35	1-3/8	34.92	1-1/2	38.10	31.24	26.41	28.19	40.38	37.84

* ISO Tapered Threads are available upon request.

All dimensions are in millimeters unless otherwise specified. Dimensions are for reference only, subject to change.

Hy-Lok Two Ferrules Tube Fittings

Male Run Tee CRTM

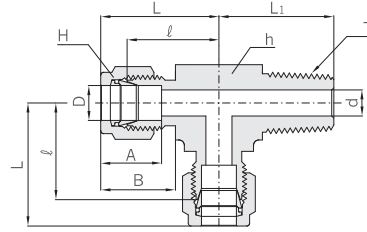

Connects Fractional Tube To Female NPT Thread

Part No.	Tube O.D. D		T* (NPT)	d Min.	Width across flat				A	B	ℓ	L	L ₁
	in	mm			h		H						
					in	mm	in	mm					
CRTM 2 - 2N	1/8	3.17	1/8	2.28	1/2	12.70	7/16	11.11	12.70	15.24	17.00	24.91	17.80
CRTM 2 - 4N	1/8	3.17	1/4	2.28	1/2	12.70	7/16	11.11	12.70	15.24	18.03	24.91	23.36
CRTM 3 - 2N	3/16	4.76	1/8	3.04	1/2	12.70	1/2	12.70	13.71	16.00	17.78	24.38	17.78
CRTM 4 - 2N	1/4	6.35	1/8	4.82	1/2	12.70	9/16	14.28	15.24	17.78	19.55	26.92	18.79
CRTM 4 - 4N	1/4	6.35	1/4	4.82	1/2	12.70	9/16	14.28	15.24	17.78	19.71	27.38	23.87
CRTM 5 - 2N	5/16	7.93	1/8	4.82	9/16	14.28	5/8	15.87	16.25	18.54	22.35	29.71	20.82
CRTM 6 - 4N	3/8	9.52	1/4	7.11	5/8	15.87	11/16	17.46	16.75	19.30	23.11	30.48	25.40
CRTM 6 - 6N	3/8	9.52	3/8	7.11	11/16	17.46	11/16	17.46	16.76	19.30	23.87	31.24	26.20
CRTM 8 - 6N	1/2	12.70	3/8	9.65	13/16	20.63	7/8	22.22	22.86	21.84	25.90	36.06	28.19
CRTM 8 - 8N	1/2	12.70	1/2	10.41	13/16	20.63	7/8	22.22	22.86	21.84	25.90	36.06	33.02
CRTM10 - 8N	5/8	15.87	1/2	11.93	15/16	23.80	1	25.40	24.38	21.84	27.94	38.10	35.05
CRTM12- 12N	3/4	19.05	3/4	15.74	1-1/16	26.98	1-1/8	28.57	24.38	21.84	28.19	38.35	36.83

* ISO Tapered Threads are available upon request.

Connects Metric Tube To Female ISO Tapered Thread

Part No.	Tube O.D. D	T* R(PT)	d Min.	Width across flat		A	B	ℓ	L	L ₁
				h	H					
CRTM 3M - 2R	3	1/8	2.4	12.7	12	12.9	15.3	17.0	23.6	17.8
CRTM 3M - 4R	3	1/4	2.4	12.7	12	12.9	15.3	18.0	24.6	23.4
CRTM 4M - 2R	4	1/8	2.4	12.7	12	13.7	16.1	18.8	25.4	18.8
CRTM 6M - 2R	6	1/8	4.8	12.7	14	15.3	17.7	19.6	27.0	18.8
CRTM 6M - 4R	6	1/4	4.8	14.2	14	15.3	17.7	19.6	27.0	23.4
CRTM 8M - 2R	8	1/8	4.8	14.3	16	16.2	18.6	21.3	28.8	19.8
CRTM 8M - 4R	8	1/4	6.4	14.3	16	16.2	18.6	21.3	28.8	24.4
CRTM 10M - 4R	10	1/4	7.1	17.5	19	17.2	19.5	23.9	31.5	28.2
CRTM 10M - 6R	10	3/8	7.9	17.5	19	17.2	19.5	23.9	31.5	28.2
CRTM 12M - 4R	12	1/4	7.1	20.6	22	22.8	22.0	25.9	36.0	28.2
CRTM 12M - 6R	12	3/8	9.5	20.6	22	22.8	22.0	25.9	36.0	28.2
CRTM 12M - 8R	12	1/2	9.5	20.6	22	22.8	22.0	25.9	36.0	33.0
CRTM 16M - 6R	16	3/8	9.5	23.8	25	24.4	22.0	27.9	38.0	30.2
CRTM 16M - 8R	16	1/2	11.9	23.8	25	24.4	22.0	27.9	38.0	35.1
CRTM 20M - 12R	20	3/4	15.9	30.0	32	26.0	22.0	34.5	44.6	41.7

* NPT Threads are available upon request.

All dimensions are in millimeters unless otherwise specified. Dimensions are for reference only, subject to change.



Male Branch Tee
CBTM

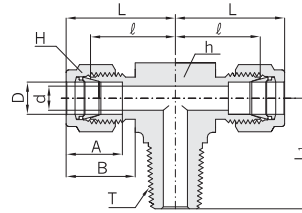

Connects Fractional Tube To Female NPT Thread

Part No.	Tube O.D. D		T* (NPT)	d Min.	Width across flat				A	B	ℓ	L	L ₁
	in	mm			h		H						
					in	mm	in	mm					
CBTM 2 - 2N	1/8	3.17	1/8	2.28	1/2	12.70	7/16	11.11	12.70	15.24	17.00	24.91	17.80
CBTM 2 - 4N	1/8	3.17	1/4	2.28	1/2	12.70	7/16	11.11	12.70	15.24	18.30	24.91	23.36
CBTM 3 - 2N	3/16	4.76	1/8	3.04	1/2	12.70	1/2	12.70	13.71	16.00	17.78	24.38	17.78
CBTM 4 - 2N	1/4	6.35	1/8	4.82	1/2	12.70	9/16	14.28	15.24	17.78	19.55	26.92	18.79
CBTM 4 - 4N	1/4	6.35	1/4	4.82	1/2	12.70	9/16	14.28	15.24	17.78	19.71	27.08	23.87
CBTM 5 - 2N	5/16	7.93	1/8	4.82	9/16	14.28	5/8	15.87	16.25	18.54	22.35	29.71	20.82
CBTM 6 - 4N	3/8	9.52	1/4	7.11	5/8	15.87	11/16	17.46	16.76	19.30	23.11	30.48	25.40
CBTM 6 - 6N	3/8	9.52	3/8	7.11	11/16	17.46	11/16	17.46	16.76	19.30	23.87	31.24	26.20
CBTM 8 - 6N	1/2	12.70	3/8	10.41	13/16	20.63	7/8	22.22	22.86	21.84	25.90	36.06	28.19
CBTM 8 - 8N	1/2	12.70	1/2	10.41	13/16	20.63	7/8	22.22	22.86	21.84	25.90	36.06	33.02
CBTM 10 - 8N	5/8	15.87	1/2	11.93	15/16	23.80	1	25.40	24.38	21.84	27.94	38.10	35.05
CBTM 12 - 12N	3/4	19.05	3/4	15.74	1-1/16	26.98	1-1/8	28.57	24.38	21.84	28.19	38.35	36.83

* ISO Tapered Threads are available upon request.

Connects Metric Tube To Female ISO Tapered Thread

Part No.	Tube O.D. D	T* R(PT)	d Min.	Width across flat		A	B	ℓ	L	L ₁
				h	H					
CBTM 3M - 2R	3	1/8	2.4	12.7	12	12.9	15.3	17.0	23.6	17.8
CBTM 3M - 4R	3	1/4	2.4	12.7	12	12.9	15.3	18.0	24.6	23.4
CBTM 4M - 2R	4	1/8	2.4	12.7	12	13.7	16.1	18.8	25.4	18.8
CBTM 6M - 2R	6	1/8	4.8	12.7	14	15.3	17.7	19.6	27.0	18.8
CBTM 6M - 4R	6	1/4	4.8	14.2	14	15.3	17.7	19.6	27.0	23.4
CBTM 8M - 2R	8	1/8	4.8	14.3	16	16.2	18.6	21.3	28.8	19.8
CBTM 8M - 4R	8	1/4	6.4	14.3	16	16.2	18.6	21.3	28.8	24.4
CBTM 10M - 4R	10	1/4	7.1	17.5	19	17.2	19.5	23.9	31.5	28.2
CBTM 10M - 6R	10	3/8	7.9	17.5	19	17.2	19.5	23.9	31.5	28.2
CBTM 12M - 4R	12	1/4	7.1	20.6	22	22.8	22.0	25.9	36.0	28.2
CBTM 12M - 6R	12	3/8	9.5	20.6	22	22.8	22.0	25.9	36.0	28.2
CBTM 12M - 8R	12	1/2	9.5	20.6	22	22.8	22.0	25.9	36.0	33.0
CBTM 16M - 6R	16	3/8	9.5	25.4	25	24.4	22.0	27.9	38.0	30.2
CBTM 16M - 8R	16	1/2	11.9	25.4	25	24.4	22.0	27.9	38.0	35.1
CBTM 20M - 12R	20	3/4	15.9	30.0	32	26.0	22.0	34.5	44.6	41.7

* NPT Threads are available upon request.

All dimensions are in millimeters unless otherwise specified. Dimensions are for reference only, subject to change.

Hy-Lok Two Ferrules Tube Fittings

Female Connector CFC

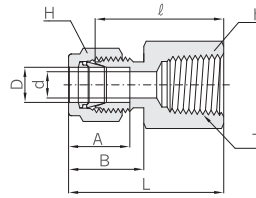

Connects Fractional Tube To Male NPT Thread

Part No.	Tube O.D. D		T* (NPT)	d Min.	Width across flat				A	B	l	L
	in	mm			h		H					
					in	mm	in	mm				
CFC 1 - 1N	1/16	1.58	1/16	1.27	7/16	11.11	5/16	7.93	8.63	10.92	19.81	23.62
CFC 1 - 2N	1/16	1.58	1/8	1.27	9/16	14.28	5/16	7.93	8.63	10.92	20.57	24.38
CFC 2 - 2N	1/8	3.17	1/8	2.28	9/16	14.28	7/16	11.11	12.70	15.24	22.09	28.70
CFC 2 - 4N	1/8	3.17	1/4	2.28	3/4	19.05	7/16	11.11	12.70	15.24	26.92	33.52
CFC 3 - 2N	3/16	4.76	1/8	3.04	9/16	14.28	1/2	12.70	13.71	16.00	23.11	29.71
CFC 4 - 2N	1/4	6.35	1/8	4.82	9/16	14.28	9/16	14.28	15.24	17.78	23.87	31.24
CFC 4 - 4N	1/4	6.35	1/4	4.82	3/4	19.05	9/16	14.28	15.24	17.78	28.44	35.81
CFC 4 - 6N	1/4	6.35	3/8	4.82	7/8	22.22	9/16	14.28	15.24	17.78	30.22	37.59
CFC 4 - 8N	1/4	6.35	1/2	4.82	1-1/16	26.98	9/16	14.28	15.24	17.78	35.05	42.41
CFC 5 - 2N	5/16	7.93	1/8	6.35	9/16	14.28	5/8	15.87	16.25	18.54	24.63	32.00
CFC 5 - 4N	5/16	7.93	1/4	6.35	3/4	19.05	5/8	15.87	16.25	18.54	29.46	36.83
CFC 6 - 2N	3/8	9.52	1/8	7.11	5/8	15.87	11/16	17.46	16.76	19.30	25.40	32.76
CFC 6 - 4N	3/8	9.52	1/4	7.11	3/4	19.05	11/16	17.46	16.76	19.30	30.22	37.59
CFC 6 - 6N	3/8	9.52	3/8	7.11	7/8	22.22	11/16	17.46	16.76	19.30	31.75	39.11
CFC 6 - 8N	3/8	9.52	1/2	7.11	1-1/16	26.98	11/16	17.46	16.76	19.30	36.57	43.94
CFC 6 - 12N	3/8	9.52	3/4	7.11	1-5/16	33.33	11/16	17.46	16.76	19.30	40.38	47.75
CFC 8 - 4N	1/2	12.70	1/4	10.41	13/16	20.63	7/8	22.22	22.86	21.84	30.22	40.38
CFC 8 - 6N	1/2	12.70	3/8	10.41	7/8	22.22	7/8	22.22	22.86	21.84	31.75	41.91
CFC 8 - 8N	1/2	12.70	1/2	10.41	1-1/16	26.98	7/8	22.22	22.86	21.84	36.57	46.73
CFC 8 - 12N	1/2	12.70	3/4	10.41	1-5/16	33.33	7/8	22.22	22.86	21.84	38.10	48.26
CFC 10 - 6N	5/8	15.87	3/8	12.70	15/16	23.80	1	25.40	24.38	21.84	31.75	41.91
CFC 10 - 8N	5/8	15.87	1/2	12.70	1-1/16	26.98	1	25.40	24.38	21.84	36.57	46.73
CFC 10 - 12N	5/8	15.87	3/4	12.70	1-5/16	33.33	1	25.40	24.38	21.84	38.10	48.26
CFC 12 - 8N	3/4	19.05	1/2	15.74	1-1/16	26.98	1-1/8	28.57	24.38	21.84	36.57	46.73
CFC 12 - 12N	3/4	19.05	3/4	15.74	1-5/16	33.33	1-1/8	28.57	24.38	21.84	38.10	48.26
CFC 14 - 12N	7/8	22.22	3/4	18.28	1-5/16	33.33	1-1/4	31.75	25.90	21.84	39.62	49.78
CFC 16 - 12N	1	25.40	3/4	22.35	1-3/8	34.92	1-1/2	38.10	31.24	26.41	41.14	53.34
CFC 16 - 16N	1	25.40	1	22.35	1-5/8	41.27	1-1/2	38.10	31.24	26.41	50.03	62.23
CFC 20 - 20N	1-1/4	31.75	1-1/4	27.68	2-1/8	53.97	1-7/8	47.62	41.14	38.86	52.57	74.67
CFC 24 - 24N	1-1/2	38.10	1-1/2	34.03	2-3/8	60.32	2-1/4	57.15	50.03	45.21	56.13	83.31
CFC 32 - 32N	2	50.80	2	45.97	2-7/8	70.03	3	76.20	67.56	62.73	64.26	101.60

* ISO Tapered Threads are available upon request.

All dimensions are in millimeters unless otherwise specified. Dimensions are for reference only, subject to change.



Female Connector CFC

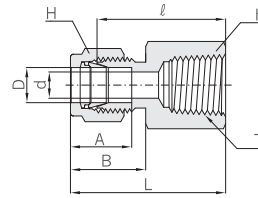

Connects Metric Tube To Male ISO Tapered Thread

Part No.	Tube O.D. D	T* R(PT)	d Min.	Width across flat		A	B	ℓ	L
				h	H				
CFC 3M - 2R	3	1/8	2.4	14	12	12.9	15.3	22.1	28.7
CFC 3M - 4R	3	1/4	2.4	19	12	12.9	15.3	26.9	33.5
CFC 4M - 2R	4	1/8	2.4	14	12	13.7	16.1	23.1	29.7
CFC 6M - 2R	6	1/8	4.8	14	14	15.3	17.7	23.9	31.3
CFC 6M - 4R	6	1/4	4.8	19	14	15.3	17.7	28.4	35.8
CFC 6M - 6R	6	3/8	4.8	22	14	15.3	17.7	29.5	36.9
CFC 6M - 8R	6	1/2	4.8	27	14	15.3	17.7	35.1	42.5
CFC 8M - 2R	8	1/8	6.4	15	16	16.2	18.6	24.6	32.1
CFC 8M - 4R	8	1/4	6.4	19	16	16.2	18.6	29.5	37.0
CFC 8M - 6R	8	3/8	6.4	22	16	16.2	18.6	30.2	37.7
CFC 8M - 8R	8	1/2	6.4	27	16	16.2	18.6	35.8	43.3
CFC 10M - 2R	10	1/8	7.9	18	19	17.2	19.5	25.4	33.0
CFC 10M - 4R	10	1/4	7.9	19	19	17.2	19.5	30.2	37.8
CFC 10M - 6R	10	3/8	7.9	22	19	17.2	19.5	31.0	38.6
CFC 10M - 8R	10	1/2	7.9	27	19	17.2	19.5	36.6	44.2
CFC 12M - 2R	12	1/8	9.5	22	22	22.8	22.0	28.4	38.5
CFC 12M - 4R	12	1/4	9.5	22	22	22.8	22.0	30.2	40.3
CFC 12M - 6R	12	3/8	9.5	22	22	22.8	22.0	31.0	41.1
CFC 12M - 8R	12	1/2	9.5	27	22	22.8	22.0	36.6	46.7
CFC 12M - 12R	12	3/4	9.5	35	22	22.8	22.0	38.9	49.0
CFC 15M - 8R	15	1/2	11.9	27	25	24.4	22.0	36.6	46.7
CFC 16M - 8R	16	1/2	12.7	27	25	24.4	22.0	36.8	46.9
CFC 20M - 8R	20	1/2	15.9	30	32	26.0	22.0	37.8	47.9
CFC 20M - 12R	20	3/4	15.9	35	32	26.0	22.0	39.6	49.7
CFC 22M - 12R	22	3/4	18.3	35	32	26.0	22.0	39.6	49.7
CFC 22M - 16R	22	1	18.3	41	32	26.0	22.0	47.8	57.9
CFC 25M - 12R	25	3/4	21.8	35	38	31.3	26.5	41.1	53.4
CFC 25M - 16R	25	1	21.8	41	38	31.3	26.5	50.0	62.3

* NPT Threads are available upon request.

Hy-Lok Two Ferrules Tube Fittings

Gauge Connector CGC

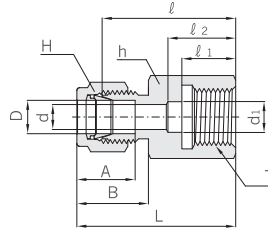

Connects Fractional Tube To ISO Parallel Thread (Gauge)

Part No.	Tube O.D. D		T G(PF)	d Min.	d ₁	Width across flat				A	B	ℓ	ℓ ₁	ℓ ₂	L
	in	mm				h		H							
						in	mm	in	mm						
CGC 4 - 2G	1/4	6.35	1/8	4.82	-	9/16	14.28	9/16	14.28	15.24	17.78	26.30	12.00	-	33.55
CGC 4 - 4G	1/4	6.35	1/4	4.82	5.58	3/4	19.05	9/16	14.28	15.24	17.78	30.22	13.00	17.00	37.59
CGC 4 - 6G	1/4	6.35	3/8	4.82	6.60	15/16	24.81	9/16	14.28	15.24	17.78	30.22	14.22	20.30	37.59
CGC 4 - 8G	1/4	6.35	1/2	4.82	6.60	11/16	26.98	9/16	14.28	15.24	17.78	30.07	18.80	24.90	43.43
CGC 5 - 4G	5/16	7.93	1/4	5.58	-	3/4	19.05	5/8	15.87	16.25	18.54	30.98	13.00	-	38.35
CGC 5 - 8G	5/16	7.93	1/2	7.11	-	1-1/16	26.98	5/8	15.87	16.25	18.54	33.02	18.80	-	40.38
CGC 6 - 4G	3/8	9.52	1/4	5.58	-	3/4	19.05	11/16	17.46	16.76	19.30	31.75	12.95	-	39.12
CGC 6 - 6G	3/8	9.52	3/8	6.60	-	15/16	24.81	11/16	17.46	16.76	19.30	31.24	14.22	-	38.61
CGC 6 - 8G	3/8	9.52	1/2	7.11	-	1-1/16	26.98	11/16	17.46	16.76	19.30	34.54	18.80	-	41.91
CGC 8 - 4G	1/2	12.70	1/4	5.5	-	7/8	22.22	7/8	22.22	22.86	21.84	31.80	13.00	-	41.95
CGC 8 - 6G	1/2	12.70	3/8	6.60	-	15/16	23.81	7/8	22.22	22.86	21.84	34.29	14.24	-	44.45
CGC 8 - 8G	1/2	12.70	1/2	7.11	7.11	1-1/16	26.98	7/8	22.22	22.86	21.84	38.10	18.80	-	48.26

Connects Metric Tube To ISO Parallel Thread (Gauge)

Part No.	Tube O.D. D	T G(PF)	d Min.	d ₁	Width across flat		A	B	ℓ	ℓ ₁	ℓ ₂	L
					h	H						
					CGC 3M - 4G	3						
CGC 6M - 4G	6	1/4	4.8	5.5	19	14	15.3	17.7	30.2	13	17	37.6
CGC 6M - 6G	6	3/8	4.8	6.5	24	14	15.3	17.7	30.2	14	20	37.6
CGC 6M - 8G	6	1/2	4.8	7.0	27	14	15.3	17.7	36.3	19	25	43.0
CGC 8M - 4G	8	1/4	5.5	-	19	16	16.2	18.6	31.0	13	-	38.5
CGC 8M - 6G	8	3/8	6.5	-	24	16	16.2	18.6	28.7	14	-	36.2
CGC 8M - 8G	8	1/2	7.0	-	27	16	16.2	18.6	33.0	19	-	40.5
CGC 10M - 4G	10	1/4	5.5	-	19	19	17.2	19.5	31.8	13	-	39.4
CGC 10M - 6G	10	3/8	6.5	-	24	19	17.2	19.5	31.2	14	-	38.8
CGC 10M - 8G	10	1/2	7.0	-	27	19	17.2	19.5	34.5	19	-	41.4
CGC 12M - 4G	12	1/4	5.5	-	22	22	22.8	22.0	31.8	13	-	41.9
CGC 12M - 6G	12	3/8	6.5	-	24	22	22.8	22.0	34.3	14	-	44.4
CGC 12M - 8G	12	1/2	7.0	-	27	22	22.8	22.0	38.1	19	-	48.2
CGC 20M - 8G	20	1/2	7.0	-	30	32	26.0	22.0	44.2	19	-	54.3
CGC 22M - 8G	22	1/2	7.0	-	30	32	26.0	22.0	44.2	19	-	54.3

All dimensions are in millimeters unless otherwise specified. Dimensions are for reference only, subject to change.

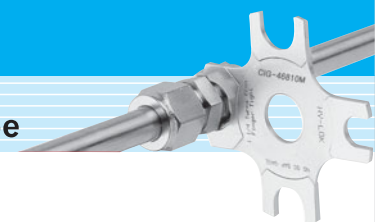

Bulkhead Female Connector
CBFC

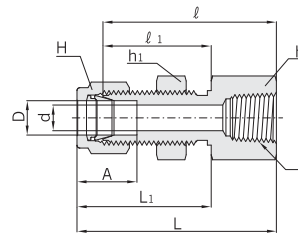

Connects Fractional Tube To Male NPT Thread

Part No.	Tube O.D. D		T* (NPT)	d Min.	Width across flat						A	ℓ	ℓ ₁	L	L ₁	Panel Hole Drill Size	Panel Max. Thickness
	in	mm			h		h ₁		H								
					in	mm	in	mm	in	mm							
CBFC 2 - 2N	1/8	3.17	1/8	2.28	9/16	14.28	1/2	12.70	7/16	11.11	12.70	38.10	24.63	44.70	31.24	8.38	12.70
CBFC 4 - 2N	1/4	6.35	1/8	4.82	5/8	15.87	5/8	15.87	9/16	14.28	15.24	39.62	26.16	46.99	33.52	11.50	10.16
CBFC 4 - 4N	1/4	6.35	1/4	4.82	3/4	19.05	5/8	15.87	9/16	14.28	15.24	44.45	26.16	51.81	33.52	11.50	10.16
CBFC 6 - 4N	3/8	9.52	1/4	7.11	3/4	19.05	3/4	19.05	11/16	17.46	16.76	47.75	29.46	55.11	36.83	14.68	11.17
CBFC 8 - 6N	1/2	12.70	3/8	10.41	15/16	23.81	15/16	23.81	7/8	22.22	22.86	51.56	31.75	61.72	41.91	19.44	12.70
CBFC 8 - 8N	1/2	12.70	1/2	10.41	1-1/16	26.98	15/16	23.81	7/8	22.22	22.86	56.38	31.75	66.54	41.91	19.44	12.70
CBFC12 - 12N	3/4	19.05	3/4	15.74	1-1/4	31.75	1-3/16	30.16	1-1/8	28.57	24.38	63.60	38.30	73.51	47.21	25.79	16.76

Connects Metric Tube To Male NPT Thread

Part No.	Tube O.D. D	T* (NPT)	d Min.	Width across flat			A	ℓ	ℓ ₁	L	L ₁	Panel Hole Drill Size	Panel Max. Thickness
				h	h ₁ †	H							
				CBFC 6M - 2N	6	1/8							
CBFC 6M - 4N	6	1/4	4.8	19.0	16.0	14	15.3	44.4	26.2	51.80	33.60	11.5	10.2
CBFC 8M - 4N	8	1/4	6.3	19.0	17.4	16	16.2	46.7	28.6	53.85	35.55	13.1	11.2
CBFC 12M - 8N	12	1/2	9.5	27.0	24.0	22	22.8	56.4	31.8	66.50	41.90	19.5	12.7

* ISO Tapered Threads are available upon request.
† h₁ : Applicable to metric Tube bulkhead hexagon only.

Hy-Lok Two Ferrules Tube Fittings

Female Elbow CLF

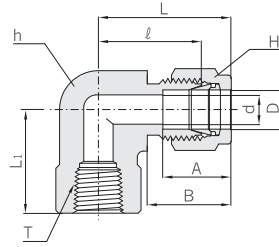

Connects Fractional Tube To Male NPT Thread

Part No.	Tube O.D. D		T* (NPT)	d Min.	Width across flat				A	B	ℓ	L	L ₁
	in	mm			h		H						
CLF 2 - 2N	1/8	3.17	1/8	2.28	1/2	12.70	7/16	11.11	12.70	15.24	18.03	24.63	19.05
CLF 2 - 4N	1/8	3.17	1/4	2.28	11/16	17.46	7/16	11.11	12.70	15.24	20.82	27.43	22.35
CLF 3 - 2N	3/16	4.76	1/8	3.04	1/2	12.70	1/2	12.70	13.71	16.00	18.79	25.40	19.05
CLF 4 - 2N	1/4	6.35	1/8	4.82	1/2	12.70	9/16	14.28	15.24	17.78	19.55	26.92	19.05
CLF 4 - 4N	1/4	6.35	1/4	4.82	11/16	17.46	9/16	14.28	15.24	17.78	22.35	29.71	22.35
CLF 4 - 6N	1/4	6.35	3/8	4.82	13/16	20.63	9/16	14.28	15.24	17.78	24.38	31.75	22.35
CLF 4 - 8N	1/4	6.35	1/2	4.82	1	25.40	9/16	14.28	15.24	17.78	27.17	34.54	28.44
CLF 5 - 2N	5/16	7.93	1/8	6.35	9/16	14.28	5/8	15.87	16.25	18.54	21.33	28.70	19.05
CLF 5 - 4N	5/16	7.93	1/4	6.35	11/16	17.46	5/8	15.87	16.25	18.54	23.11	30.48	22.35
CLF 6 - 2N	3/8	9.52	1/8	7.11	5/8	15.87	11/16	17.46	16.76	19.30	23.11	30.48	19.05
CLF 6 - 4N	3/8	9.52	1/4	7.11	11/16	17.46	11/16	17.46	16.76	19.30	23.87	31.24	22.35
CLF 6 - 6N	3/8	9.52	3/8	7.11	13/16	20.63	11/16	17.46	16.76	19.30	25.90	33.27	22.35
CLF 6 - 8N	3/8	9.52	1/2	7.11	1	25.40	11/16	17.46	16.76	19.30	28.70	36.06	28.44
CLF 8 - 4N	1/2	12.70	1/4	10.41	13/16	20.63	7/8	22.22	22.86	21.84	25.90	36.06	22.35
CLF 8 - 6N	1/2	12.70	3/8	10.41	13/16	20.63	7/8	22.22	22.86	21.84	25.90	36.06	22.35
CLF 8 - 8N	1/2	12.70	1/2	10.41	1	25.40	7/8	22.22	22.86	21.84	28.70	38.86	28.44
CLF 10 - 6N	5/8	15.87	3/8	12.70	15/16	23.80	1	25.40	24.38	21.84	27.94	38.10	22.35
CLF 10 - 8N	5/8	15.87	1/2	12.70	1	25.40	1	25.40	24.38	21.84	29.71	39.87	28.44
CLF 12 - 8N	3/4	19.05	1/2	15.74	1-1/16	26.98	1-1/8	28.57	24.38	21.84	29.71	39.87	28.44
CLF 12 - 12N	3/4	19.05	3/4	15.74	1-3/8	34.92	1-1/8	28.57	24.38	21.84	34.54	44.70	31.75
CLF 14 - 12N	7/8	22.22	3/4	18.28	1-3/8	34.92	1-1/4	31.75	25.90	21.84	34.54	44.70	31.75
CLF 16 - 12N	1	25.40	3/4	22.35	1-3/8	34.92	1-1/2	38.10	31.24	26.41	36.83	49.02	31.75
CLF 16 - 16N	1	25.40	1	22.35	1-11/16	42.86	1-1/2	38.10	31.24	26.41	38.10	50.29	38.10

Connects Metric Tube To Male NPT Thread

Part No.	Tube O.D. D	T* (NPT)	d Min.	Width across flat		A	B	ℓ	L	L ₁
				h	H					
CLF 6M - 2N	6	1/8	4.8	12.7	14	15.3	17.7	19.6	27.0	19.00
CLF 6M - 4N	6	1/4	4.8	17.5	14	15.3	17.7	22.4	29.8	22.40
CLF 6M - 6N	6	3/8	4.8	20.6	14	15.3	17.7	24.4	31.7	22.40
CLF 6M - 8N	6	1/2	4.8	25.4	14	15.3	17.7	27.2	34.6	28.40
CLF 8M - 4N	8	1/4	6.4	17.5	16	16.2	18.6	23.1	30.6	22.40
CLF 8M - 8N	8	1/2	6.4	20.6	16	16.2	18.6	28.0	35.2	28.40
CLF10M - 2N	10	1/8	7.9	17.5	19	17.2	19.5	23.9	31.5	19.00
CLF10M - 4N	10	1/4	7.9	17.5	19	17.2	19.5	25.9	33.5	22.40
CLF10M - 6N	10	3/8	7.9	20.6	19	17.2	19.5	25.9	33.5	22.40
CLF10M - 8N	10	1/2	7.9	25.4	19	17.2	19.5	28.7	36.1	28.40
CLF12M - 4N	12	1/4	9.5	20.6	22	22.8	22.0	25.9	36.0	22.40
CLF12M - 6N	12	3/8	9.5	20.6	22	22.8	22.0	25.9	36.0	22.40
CLF12M - 8N	12	1/2	9.5	25.4	22	22.8	22.0	28.7	38.8	28.40
CLF16M - 8N	16	1/2	12.7	27.0	25	24.4	22.0	29.7	39.5	28.40

* ISO Tapered Threads are available upon request.

All dimensions are in millimeters unless otherwise specified. Dimensions are for reference only, subject to change.



Female Run Tee
CRTF

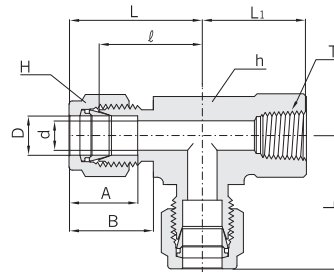

Connects Fractional Tube To Male NPT Thread

Part No.	Tube O.D. D		T* (NPT)	d Min.	Width across flat				A	B	ℓ	L	L ₁
	in	mm			h		H						
					in	mm	in	mm					
CRTF 2 - 2N	1/8	3.17	1/8	2.28	1/2	12.70	7/16	11.11	12.70	15.24	18.03	24.63	19.05
CRTF 4 - 2N	1/4	6.35	1/8	4.82	1/2	12.70	9/16	14.28	15.24	17.78	19.55	26.92	19.05
CRTF 4 - 4N	1/4	6.35	1/4	4.82	11/16	17.46	9/16	14.28	15.24	17.78	22.86	29.71	22.35
CRTF 6 - 4N	3/8	9.52	1/4	7.11	11/16	17.46	11/16	17.46	16.76	19.30	23.87	31.24	22.35
CRTF 8 - 6N	1/2	12.70	3/8	10.41	13/16	20.63	7/8	22.22	22.86	21.84	25.90	36.06	22.35
CRTF 8 - 8N	1/2	12.70	1/2	10.41	1	25.40	7/8	22.22	22.86	21.84	29.71	39.87	28.44
CRTF12 -12N	3/4	19.05	3/4	15.74	1-3/8	34.92	1-1/8	28.57	24.38	21.84	34.54	44.70	31.75
CRTF16 -12N	1	25.40	3/4	22.35	1-3/8	34.92	1-1/2	38.10	31.24	26.41	36.83	49.02	31.75
CRTF16 -16N	1	25.40	1	22.35	1-11/16	42.86	1-1/2	38.10	31.24	26.41	41.40	53.59	38.10

Connects Metric Tube To Male NPT Thread

Part No.	Tube O.D. D	T* (NPT)	d Min.	Width across flat		A	B	ℓ	L	L ₁
				h	H					
CRTF 6M - 2N	6	1/8	4.8	12.7	14	15.3	17.7	19.6	27.0	19.0
CRTF 6M - 4N	6	1/4	4.8	17.5	14	15.3	17.7	22.4	29.8	22.4
CRTF 6M - 8N	6	1/2	4.8	25.4	14	15.3	17.7	27.2	34.5	28.4
CRTF 8M - 2N	8	1/8	6.4	15.8	16	16.2	18.6	22.4	29.9	19.0
CRTF 8M - 4N	8	1/4	6.4	17.5	16	16.2	18.6	23.1	30.6	22.4
CRTF 8M - 6N	8	3/8	6.4	20.6	16	16.2	18.6	25.2	32.4	22.4
CRTF 8M - 8N	8	1/2	6.4	25.4	16	16.2	18.6	28.0	35.2	28.4
CRTF 10M - 4N	10	1/4	7.9	20.6	19	17.2	19.5	25.9	33.5	22.4
CRTF 12M - 4N	12	1/4	9.5	20.6	22	22.8	22.0	25.9	36.0	22.4
CRTF 12M - 6N	12	3/8	9.5	20.6	22	22.8	22.0	25.9	36.0	22.4
CRTF 12M - 8N	12	1/2	9.5	25.4	22	22.8	22.0	28.7	38.8	28.4
CRTF 16M - 8N	16	1/2	12.7	25.4	25	24.4	22.0	29.7	39.5	28.4

* ISO Tapered Threads are available upon request.

Female Branch Tee.

CBTF

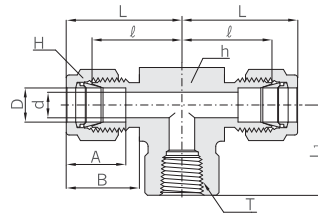

Connects Fractional Tube To Male NPT Thread

Part No.	Tube O.D. D		T* (NPT)	d Min.	Width across flat				A	B	ℓ	L	L ₁
	in	mm			h		H						
					in	mm	in	mm					
CBTF 2 - 2N	1/8	3.17	1/8	2.28	1/2	12.70	7/16	11.11	12.70	15.24	18.03	24.38	19.05
CBTF 4 - 2N	1/4	6.35	1/8	4.82	1/2	12.70	9/16	14.28	15.24	17.78	19.55	26.92	19.05
CBTF 4 - 4N	1/4	6.35	1/4	4.82	11/16	17.46	9/16	14.28	15.24	17.78	22.35	29.71	22.35
CBTF 6 - 4N	3/8	9.52	1/4	7.11	11/16	17.46	11/16	17.46	16.76	19.30	23.87	31.24	22.35
CBTF 8 - 4N	1/2	12.70	1/4	10.41	13/16	20.63	7/8	22.22	22.86	21.84	25.90	36.06	22.35
CBTF 8 - 6N	1/2	12.70	3/8	10.41	13/16	20.63	7/8	22.22	22.86	21.84	25.90	36.06	22.35
CBTF 8 - 8N	1/2	12.70	1/2	10.41	1	25.40	7/8	22.22	22.86	21.84	28.70	38.86	28.44
CBTF10 - 8N	5/8	15.87	1/2	12.70	1	25.40	1	25.40	24.38	21.84	28.70	38.86	28.44
CBTF12 - 12N	3/4	19.05	3/4	15.74	1-3/8	34.92	1-1/8	28.57	24.38	21.84	34.54	44.70	31.75
CBTF16 - 12N	1	25.40	3/4	22.35	1-3/8	34.92	1-1/2	38.10	31.24	26.41	36.83	49.02	31.75
CBTF16 - 16N	1	25.40	1	22.35	1-11/16	42.86	1-1/2	38.10	31.24	26.41	44.20	53.59	38.10

Connects Metric Tube To Male NPT Thread

Part No.	Tube O.D. D	T* (NPT)	d Min.	Width across flat		A	B	ℓ	L	L ₁
				h	H					
CBTF 6M - 2N	6	1/8	4.8	12.7	14	15.3	17.7	19.6	27.0	19.0
CBTF 6M - 4N	6	1/4	4.8	17.5	14	15.3	17.7	22.4	29.8	22.4
CBTF 6M - 6N	6	3/8	4.8	20.6	14	15.3	17.7	24.4	31.7	22.4
CBTF 6M - 8N	6	1/2	4.8	25.4	14	15.3	17.7	27.2	34.5	28.4
CBTF 8M - 2N	8	1/8	6.4	15.8	16	16.2	18.6	23.1	29.9	19.0
CBTF 8M - 4N	8	1/4	6.4	17.5	16	16.2	18.6	23.1	30.6	22.4
CBTF 8M - 6N	8	3/8	6.4	20.6	16	16.2	18.6	25.2	32.4	22.4
CBTF 8M - 8N	8	1/2	6.4	25.4	16	16.2	18.6	28.0	35.2	28.4
CBTF10M - 4N	10	1/4	7.9	20.6	19	17.2	19.5	25.9	33.5	22.4
CBTF10M - 6N	10	3/8	7.9	20.6	19	17.2	19.5	25.9	33.3	22.4
CBTF10M - 8N	10	1/2	9.5	25.4	19	17.2	19.5	26.2	33.6	22.4
CBTF12M - 4N	12	1/4	9.5	20.6	22	22.8	22.0	25.9	36.0	22.4
CBTF12M - 6N	12	3/8	9.5	20.6	22	22.8	22.0	25.9	36.0	22.4
CBTF12M - 8N	12	1/2	9.5	25.4	22	22.8	22.0	28.7	38.8	28.4
CBTF16M - 8N	16	1/2	12.7	25.4	25	24.4	22.0	29.7	39.5	28.7

* ISO Tapered threads are available upon request.

All dimensions are in millimeters unless otherwise specified. Dimensions are for reference only, subject to change.

Stub Tube Connector

Reducer CR

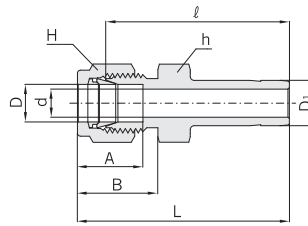

*Connects Fractional Tube To Fractional Hy-Lok Port

Part No.	Tube O.D.				d Min.	Width across flat				A	B	l	L
	D	D ₁	D	D ₁		h	H	h	H				
	in	mm	in	mm		in	mm	in	mm				
CR 1 - 2	1/16	1.58	1/8	3.17	1.27	5/16	7.93	5/16	7.93	8.63	10.92	25.40	29.21
CR 1 - 4	1/16	1.58	1/4	6.35	1.27	5/16	7.93	5/16	7.93	8.63	10.92	27.68	31.49
CR 2 - 1	1/8	3.17	1/16	1.58	0.76	7/16	11.11	7/16	11.11	12.70	15.24	22.35	28.95
CR 2 - 2	1/8	3.17	1/8	3.17	2.03	7/16	11.11	7/16	11.11	12.70	15.24	26.92	33.52
CR 2 - 3	1/8	3.17	3/16	4.76	2.28	7/16	11.11	7/16	11.11	12.70	15.24	27.68	34.29
CR 2 - 4	1/8	3.17	1/4	6.35	2.28	7/16	11.11	7/16	11.11	12.70	15.24	29.46	36.06
CR 2 - 6	1/8	3.17	3/8	9.52	2.28	7/16	11.11	7/16	11.11	12.70	15.24	30.98	37.59
CR 2 - 8	1/8	3.17	1/2	12.70	2.28	9/16	14.28	7/16	11.11	12.70	15.24	37.59	44.19
CR 3 - 2	3/16	4.76	1/8	3.17	2.03	7/16	11.11	1/2	12.70	13.71	16.00	28.19	34.79
CR 3 - 4	3/16	4.76	1/4	6.35	3.04	7/16	11.11	1/2	12.70	13.71	16.00	30.48	37.08
CR 4 - 2	1/4	6.35	1/8	3.17	2.03	1/2	12.70	9/16	14.28	15.24	17.78	29.46	36.83
CR 4 - 3	1/4	6.35	3/16	4.76	3.04	1/2	12.70	9/16	14.28	15.24	17.78	30.22	37.59
CR 4 - 4	1/4	6.35	1/4	6.35	4.32	1/2	12.70	9/16	14.28	15.24	17.78	31.75	39.11
CR 4 - 5	1/4	6.35	5/16	7.93	4.82	1/2	12.70	9/16	14.28	15.24	17.78	32.51	39.87
CR 4 - 6	1/4	6.35	3/8	9.52	4.82	1/2	12.70	9/16	14.28	15.24	17.78	33.27	40.64
CR 4 - 8	1/4	6.65	1/2	12.70	4.82	9/16	14.28	9/16	14.28	15.24	17.78	38.86	46.22
CR 4 - 10	1/4	6.35	5/8	15.87	4.82	11/16	17.46	9/16	14.28	15.24	17.78	40.64	48.00
CR 4 - 12	1/4	6.35	3/4	19.05	4.82	13/16	20.63	9/16	14.28	15.24	17.78	40.38	47.75
CR 5 - 6	5/16	7.93	3/8	9.52	6.35	9/16	14.28	5/8	15.87	16.25	18.54	34.54	41.91
CR 5 - 8	5/16	7.93	1/2	12.70	6.35	9/16	14.28	5/8	15.87	16.25	18.54	40.13	47.49
CR 6 - 4	3/8	9.52	1/4	6.32	4.32	5/8	15.87	11/16	17.46	16.76	19.30	34.03	41.40
CR 6 - 6	3/8	9.52	3/8	6.86	6.86	5/8	15.87	11/16	17.46	16.76	19.30	35.81	43.18
CR 6 - 8	3/8	9.52	1/2	12.70	7.11	5/8	15.87	11/16	17.46	16.76	19.30	41.14	48.51
CR 6 - 10	3/8	9.52	5/8	15.87	7.11	11/16	17.46	11/16	17.46	16.76	19.30	42.92	50.29
CR 6 - 12	3/8	9.52	3/4	19.05	7.11	13/16	20.63	11/16	17.46	16.76	19.30	42.92	50.29
CR 8 - 4	1/2	12.70	1/4	6.35	4.32	13/16	20.63	7/8	22.22	22.86	21.84	34.79	44.95
CR 8 - 6	1/2	12.70	3/8	9.52	6.86	13/16	20.63	7/8	22.22	22.86	21.84	36.57	46.73
CR 8 - 8	1/2	12.70	1/2	12.70	9.40	13/16	20.63	7/8	22.22	22.86	21.84	42.16	52.32
CR 8 - 10	1/2	12.70	5/8	15.87	10.41	13/16	20.63	7/8	22.22	22.86	21.84	43.68	53.84
CR 8 - 12	1/2	12.70	3/4	19.05	10.41	13/16	20.63	7/8	22.22	22.86	21.84	43.68	53.84
CR 8 - 16	1/2	12.70	1	25.40	10.41	1-1/16	26.98	7/8	22.22	22.86	21.84	50.03	60.19
CR10 - 12	5/8	15.87	3/4	19.05	12.70	15/16	23.81	1	25.40	24.38	21.84	44.45	54.61
CR10 - 14	5/8	15.87	7/8	22.22	12.70	15/16	23.81	1	25.40	24.38	21.84	45.97	56.13
CR10 - 16	5/8	15.87	1	25.40	12.70	1-1/16	26.98	1	25.40	24.38	21.84	50.80	60.96
CR12 - 8	3/4	19.05	1/2	12.70	9.40	1-1/16	26.98	1-1/8	28.57	24.38	21.84	44.45	54.61
CR12 - 16	3/4	19.05	1	25.40	15.74	1-1/16	26.98	1-1/8	28.57	24.38	21.84	52.32	62.48
CR16 - 20	1	25.40	1-1/4	31.75	22.35	1-3/8	34.92	1-1/2	38.10	31.24	26.41	68.32	80.51
CR16 - 24	1	25.40	1-1/2	38.10	22.35	1-5/8	41.27	1-1/2	38.10	31.24	26.41	76.96	89.15
CR16 - 32	1	25.40	2	50.80	22.35	2-1/8	53.97	1-1/2	38.10	31.24	26.41	100.33	112.52
CR20 - 24	1-1/4	31.75	1-1/2	38.10	27.68	1-7/8	47.62	2-1/4	57.15	41.14	38.86	82.04	104.14
CR20 - 32	1-1/4	31.75	2	50.80	27.68	1-7/8	47.62	3	76.20	41.14	38.86	103.12	125.22
CR24 - 32	1-1/2	38.10	2	50.80	34.03	2-1/4	57.15	3	76.20	50.03	45.21	104.14	131.31

* Connects fractional tube to metric Hy-Lok port are available upon request.

All dimensions are in millimeters unless otherwise specified. Dimensions are for reference only, subject to change.

Hy-Lok Two Ferrules Tube Fittings

Reducer CR

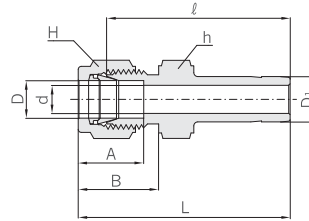

Connects Metric Tube To Metric Hy-Lok Port

Part No.	Tube O.D.		d Min.	Width across flat		A	B	ℓ	L
	D	D ₁		h	H				
CR 2M - 3M	2	3	1.7	12	12	12.9	15.3	26.9	33.5
CR 3M - 4M	3	4	2.2	12	12	12.9	15.3	28.4	35.0
CR 3M - 6M	3	6	2.4	12	12	12.9	15.3	29.5	36.1
CR 3M - 10M	3	10	2.4	12	12	12.9	15.3	31.8	38.4
CR 4M - 6M	4	6	2.4	12	12	13.7	16.1	30.5	37.1
CR 6M - 3M	6	3	1.9	14	14	15.3	17.7	29.5	36.9
CR 6M - 8M	6	8	4.8	14	14	15.3	17.7	32.5	39.9
CR 6M - 10M	6	10	4.8	14	14	15.3	17.7	33.3	40.7
CR 6M - 12M	6	12	4.8	14	14	15.3	17.7	38.9	46.3
CR 8M - 6M	8	6	4.1	15	16	16.2	18.6	32.8	40.3
CR 8M - 10M	8	10	6.4	15	16	16.2	18.6	34.5	42.0
CR 8M - 12M	8	12	6.4	15	16	16.2	18.6	40.1	47.6
CR10M - 6M	10	6	4.1	18	19	17.2	19.5	34.8	42.4
CR10M - 12M	10	12	7.9	18	19	17.2	19.5	42.2	49.8
CR10M - 15M	10	15	7.9	18	19	17.2	19.5	43.7	51.3
CR10M - 18M	10	18	7.9	19	19	17.2	19.5	43.7	51.3
CR12M - 6M	12	6	4.1	22	22	22.8	22.0	34.8	44.9
CR12M - 10M	12	10	7.1	22	22	22.8	22.0	36.6	46.7
CR12M - 16M	12	16	9.5	22	22	22.8	22.0	43.7	53.8
CR12M - 18M	12	18	9.5	22	22	22.8	22.0	43.7	53.8
CR12M - 20M	12	20	9.5	22	22	22.8	22.0	46.0	56.1
CR12M - 22M	12	22	9.5	24	22	22.8	22.0	46.0	56.1
CR12M - 25M	12	25	9.5	27	22	22.8	22.0	52.3	62.4
CR16M - 12M	16	12	8.8	24	25	24.4	22.0	42.9	53.0
CR18M - 12M	18	12	8.8	27	30	24.4	22.0	44.5	54.6
CR18M - 16M	18	16	12.0	27	30	24.4	22.0	46.0	56.1
CR18M - 20M	18	20	15.1	27	30	24.4	22.0	47.5	57.6
CR18M - 22M	18	22	15.1	27	30	24.4	22.0	47.5	57.6
CR18M - 25M	18	25	15.1	27	30	24.4	22.0	52.3	62.4
CR20M - 16M	20	16	12.0	30	32	26.0	22.0	47.8	57.9
CR20M - 18M	20	18	13.9	30	32	26.0	22.0	47.8	57.9
CR20M - 22M	20	22	15.8	30	32	26.0	22.0	49.3	59.4
CR20M - 25M	20	25	15.8	30	32	26.0	22.0	54.1	64.2
CR22M - 18M	22	18	13.9	30	32	26.0	22.0	47.8	57.9
CR22M - 20M	22	20	15.1	30	32	26.0	22.0	49.3	59.4
CR22M - 25M	22	25	18.3	30	32	26.0	22.0	54.1	64.2
CR25M - 18M	25	18	13.9	35	38	31.3	26.5	50.8	63.1
CR25M - 20M	25	20	15.5	35	38	31.3	26.5	52.3	64.6

All dimensions are in millimeters unless otherwise specified. Dimensions are for reference only, subject to change.



Reducer CR

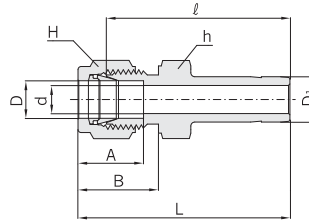

Connects Metric Tube To Fractional Hy-Lok Port

Part No.	Tube O.D.			d Min.	Width across flat		A	B	l	L
	D	D ₁								
CR 2M - 2	2	1/8	3.17	1.7	12	12	12.9	15.3	26.9	33.5
CR 3M - 2	3	1/8	3.17	2.0	12	12	12.9	15.3	26.9	33.5
CR 3M - 4	3	1/4	6.35	2.4	12	12	12.9	15.3	29.5	36.1
CR 4M - 4	4	1/4	6.35	2.4	12	12	13.7	16.1	30.5	37.1
CR 6M - 2	6	1/8	3.17	2.0	14	14	15.3	17.7	29.5	36.9
CR 6M - 4	6	1/4	6.35	4.3	14	14	15.3	17.7	31.8	39.2
CR 6M - 5	6	5/16	7.93	4.8	14	14	15.3	17.7	32.5	39.9
CR 6M - 6	6	3/8	9.52	4.8	14	14	15.3	17.7	33.3	40.7
CR 6M - 8	6	1/2	12.70	4.8	14	14	15.3	17.7	38.9	46.3
CR 8M - 6	8	3/8	9.52	6.4	15	16	16.2	18.6	34.5	42.0
CR 8M - 8	8	1/2	12.70	6.4	15	16	16.2	18.6	40.1	47.6
CR 10M - 6	10	3/8	9.52	6.9	18	19	17.2	19.5	36.6	44.2
CR 10M - 8	10	1/2	12.70	7.9	18	19	17.2	19.5	42.2	49.8
CR 12M - 8	12	1/2	12.70	9.4	22	22	22.8	22.0	42.2	52.3
CR 12M - 12	12	3/4	19.05	9.5	22	22	22.8	22.0	43.7	53.8
CR 18M - 12	18	3/4	19.05	14.7	27	30	24.4	22.0	46.0	56.1
CR 18M - 16	18	1	25.40	15.1	27	30	24.4	22.0	52.3	62.4
CR 25M - 16	25	1	25.40	20.2	35	38	31.3	26.5	57.2	69.5

Bulkhead Reducer CBR

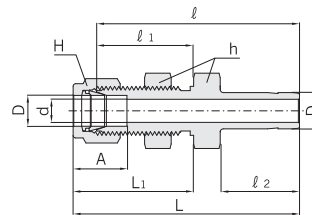

Connects Fractional Tube To Fractional Hy-Lok Port

Part No.	Tube O.D.		d Min.	Width across flat				A	l	l ₁	l ₂	L	L ₁	Panel Hole Drill Size	Panel Max. Thickness
	D			h		H									
	in	mm		in	mm	in	mm								
CBR 2 - 2	1/8	3.17	2.03	1/2	12.70	7/16	11.11	12.70	42.92	24.63	13.46	49.53	31.24	8.33	12.70
CBR 4 - 4	1/4	6.35	4.32	5/8	15.87	9/16	14.28	15.24	48.51	26.16	15.74	55.88	33.52	11.50	10.16
CBR 6 - 6	3/8	9.52	6.86	3/4	19.05	11/16	17.46	16.76	53.84	29.46	17.52	61.21	36.83	14.68	11.17
CBR 8 - 8	1/2	12.70	9.40	15/16	23.81	7/8	22.22	22.86	62.73	31.75	23.11	72.89	41.91	19.44	12.70
CBR10 - 10	5/8	15.87	11.94	1-1/16	26.98	1	25.40	24.38	65.02	32.51	24.70	75.18	42.67	22.62	12.70
CBR16 - 16	1	25.40	20.32	1-5/8	41.27	1-1/2	38.10	31.24	88.13	45.21	31.70	100.33	57.40	33.73	19.05

All dimensions are in millimeters unless otherwise specified. Dimensions are for reference only, subject to change.

Hy-Lok Two Ferrules Tube Fittings

Adjustable Elbow CAL

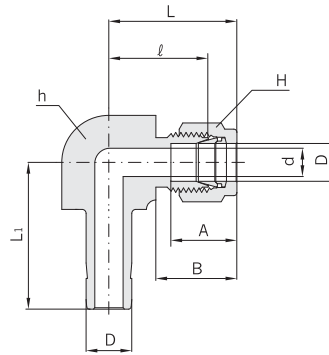

Connects Fractional Tube To Fractional Hy-Lok Port

Part No.	Tube O.D. D		d Min.	Width across flat				A	B	ℓ	L	L ₁
	in	mm		h		H						
				inch	mm	inch	mm					
CAL - 1	1/16	1.58	0.76	3/8	9.52	5/16	7.93	8.63	10.92	14.00	22.3	16.00
CAL - 2	1/8	3.17	2.03	3/8	9.52	7/16	11.11	12.70	15.24	15.74	22.3	20.59
CAL - 3	3/16	4.76	3.04	1/2	12.70	1/2	12.70	13.71	16.00	17.78	25.4	22.48
CAL - 4	1/4	6.35	4.32	1/2	12.70	9/16	14.28	15.24	17.78	19.55	27.0	25.00
CAL - 5	5/16	7.93	5.59	9/16	14.28	5/8	15.87	16.25	18.54	21.33	28.8	27.08
CAL - 6	3/8	9.52	6.86	5/8	15.87	11/16	17.46	16.76	19.30	23.11	31.5	26.00
CAL - 8	1/2	12.70	9.40	13/16	20.63	7/8	22.22	22.86	21.84	25.90	36.0	37.30
CAL - 10	5/8	15.87	11.94	15/16	23.80	1	25.40	24.38	21.84	28.70	38.8	41.75
CAL - 12	3/4	19.05	14.73	1-1/16	26.98	1-1/8	28.57	24.38	21.84	29.71	38.8	42.60
CAL - 14	7/8	22.22	18.28	1-3/16	30.00	1-1/4	31.75	25.90	21.84	34.54	39.8	49.39
CAL - 16	1	25.40	20.32	1-3/8	34.92	1-1/2	38.10	31.24	26.41	46.83	42.6	55.60

Connects Metric Tube To Metric Hy-Lok Port

Part No.	Tube O.D. D	d Min.	Width across flat		A	B	ℓ	L	L ₁
			h	H					
CAL - 3M	3	1.9	9.5	12	12.9	15.3	15.7	22.3	20.5
CAL - 4M	4	2.2	12.7	12	13.7	16.4	18.8	25.4	23.0
CAL - 6M	6	4.1	12.7	14	15.3	17.7	19.6	27.0	25.1
CAL - 8M	8	5.6	14.3	16	16.2	18.6	21.3	28.8	27.2
CAL - 10M	10	7.1	17.5	19	17.2	19.5	23.9	31.5	29.5
CAL - 12M	12	8.8	20.6	22	22.8	22.0	25.9	36.0	37.3
CAL - 15M	15	11.2	23.8	25	24.4	22.0	28.7	38.8	41.6
CAL - 16M	16	12.0	23.8	25	24.4	22.0	28.7	38.8	41.8
CAL - 18M	18	13.9	27.0	30	24.4	22.0	29.7	39.8	42.6
CAL - 20M	20	15.5	30.0	32	26.0	22.0	32.5	42.6	67.1
CAL - 22M	22	16.1	30.0	32	26.0	22.0	32.5	42.6	47.2
CAL - 25M	25	19.9	34.9	38	31.3	26.5	36.8	49.1	55.6
CAL - 28M	28	22.5	41.0	46	36.6	36.6	43.2	64.0	65.0

All dimensions are in millimeters unless otherwise specified. Dimensions are for reference only, subject to change.



Adjustable Run Tee CRTA

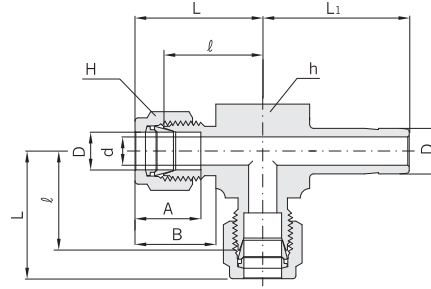

Connects Fractional Tube To Fractional Hy-Lok Port

Part No.	Tube O.D. D		d Min.	Width across flat				A	B	ℓ	L	L ₁
	in	mm		h		H						
				in	mm	in	mm					
CRTA - 1	1/16	1.58	0.76	3/8	9.52	5/16	7.93	8.63	10.92	14.00	22.3	16.00
CRTA - 2	1/8	3.17	2.03	3/8	9.52	7/16	11.11	12.70	15.24	15.74	22.3	20.59
CRTA - 3	3/16	4.76	3.04	1/2	12.70	1/2	12.70	13.71	16.00	17.78	25.4	22.48
CRTA - 4	1/4	6.35	4.32	1/2	12.70	9/16	14.28	15.24	17.78	19.55	27.0	25.00
CRTA - 5	5/16	7.93	5.59	9/16	14.28	5/8	15.87	16.25	18.54	21.33	28.8	27.08
CRTA - 6	3/8	9.52	6.86	5/8	15.87	11/16	17.46	16.76	19.30	23.11	31.5	26.00
CRTA - 8	1/2	12.70	9.40	13/16	20.63	7/8	22.22	22.86	21.84	25.90	36.0	37.30
CRTA - 10	5/8	15.87	11.94	15/16	23.80	1	25.40	24.38	21.84	28.70	38.8	41.75
CRTA - 12	3/4	19.05	14.73	1-1/16	26.98	1-1/8	28.57	24.38	21.84	29.71	38.8	42.60
CRTA - 14	7/8	22.22	18.28	1-3/16	30.00	1-1/4	31.75	25.90	21.84	34.54	39.8	49.39
CRTA - 16	1	25.40	20.32	1-3/8	34.92	1-1/2	38.10	31.24	26.41	46.83	42.6	55.60

Connects Metric Tube To Metric Hy-Lok Port

Part No.	Tube O.D. D	d Min.	Width across flat		A	B	ℓ	L	L ₁
			h	H					
CRTA - 3M	3	1.9	9.5	12	12.9	15.3	15.7	22.3	20.5
CRTA - 4M	4	2.2	12.7	12	13.7	16.4	18.8	25.4	23.0
CRTA - 6M	6	4.1	12.7	14	15.3	17.7	19.6	27.0	25.1
CRTA - 8M	8	5.6	14.3	16	16.2	18.6	21.3	28.8	27.2
CRTA - 10M	10	7.1	17.5	19	17.2	19.5	23.9	31.5	29.5
CRTA - 12M	12	8.8	20.6	22	22.8	22.0	25.9	36.0	37.3
CRTA - 15M	15	11.2	23.8	25	24.4	22.0	28.7	38.8	41.6
CRTA - 16M	16	12.0	23.8	25	24.4	22.0	28.7	38.8	41.8
CRTA - 18M	18	13.9	27.0	30	24.4	22.0	29.7	39.8	42.6
CRTA - 20M	20	15.5	30.0	32	26.0	22.0	32.5	42.6	67.1
CRTA - 22M	22	16.1	30.0	32	26.0	22.0	32.5	42.6	47.2
CRTA - 25M	25	19.9	34.9	38	31.3	26.5	36.8	49.1	55.6
CRTA - 28M	28	22.5	41.0	46	36.6	36.6	43.2	64.0	65.0

All dimensions are in millimeters unless otherwise specified. Dimensions are for reference only, subject to change.

Hy-Lok Two Ferrules Tube Fittings

Adjustable Branch Tee CBTA

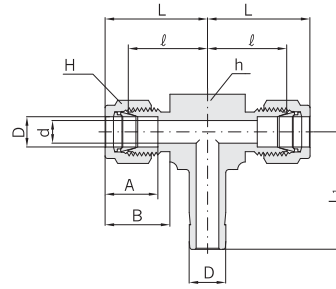

Connects Fractional Tube To Fractional Hy-Lok Port

Part No.	Tube O.D. D		d Min.	Width across flat				A	B	ℓ	L	L ₁
	in	mm		h		H						
				in	mm	in	mm					
CBTA - 1	1/16	1.58	0.76	3/8	9.52	5/16	7.93	8.63	10.92	14.00	22.3	16.00
CBTA - 2	1/8	3.17	2.03	3/8	9.52	7/16	11.11	12.70	15.24	15.74	22.3	20.59
CBTA - 3	3/16	4.76	3.04	1/2	12.70	1/2	12.70	13.71	16.00	17.78	25.4	22.48
CBTA - 4	1/4	6.35	4.32	1/2	12.70	9/16	14.28	15.24	17.78	19.55	27.0	25.00
CBTA - 5	5/16	7.93	5.59	9/16	14.28	5/8	15.87	16.25	18.54	21.33	28.8	27.08
CBTA - 6	3/8	9.52	6.86	5/8	15.87	11/16	17.46	16.76	19.30	23.11	31.5	26.00
CBTA - 8	1/2	12.70	9.40	13/16	20.63	7/8	22.22	22.86	21.84	25.90	36.0	37.30
CBTA - 10	5/8	15.87	11.94	15/16	23.80	1	25.40	24.38	21.84	28.70	38.8	41.75
CBTA - 12	3/4	19.05	14.73	1-1/16	26.98	1-1/8	28.57	24.38	21.84	29.71	38.8	42.60
CBTA - 14	7/8	22.22	18.28	1-3/16	30.00	1-1/4	31.75	25.90	21.84	34.54	39.8	49.39
CBTA - 16	1	25.40	20.32	1-3/8	34.92	1-1/2	38.10	31.24	26.41	46.83	42.6	55.60

Connects Metric Tube To Metric Hy-Lok Port

Part No.	Tube O.D. D	d Min.	Width across flat		A	B	ℓ	L	L ₁
			h	H					
CBTA - 3M	3	1.9	9.5	12	12.9	15.3	15.7	22.3	20.5
CBTA - 4M	4	2.2	12.7	12	13.7	16.4	18.8	25.4	23.0
CBTA - 6M	6	4.1	12.7	14	15.3	17.7	19.6	27.0	25.1
CBTA - 8M	8	5.6	14.3	16	16.2	18.6	21.3	28.8	27.2
CBTA - 10M	10	7.1	17.5	19	17.2	19.5	23.9	31.5	29.5
CBTA - 12M	12	8.8	20.6	22	22.8	22.0	25.9	36.0	37.3
CBTA - 15M	15	11.2	23.8	25	24.4	22.0	28.7	38.8	41.6
CBTA - 16M	16	12.0	23.8	25	24.4	22.0	28.7	38.8	41.8
CBTA - 18M	18	13.9	27.0	30	24.4	22.0	29.7	39.8	42.6
CBTA - 20M	20	15.5	30.0	32	26.0	22.0	32.5	42.6	67.1
CBTA - 22M	22	16.1	30.0	32	26.0	22.0	32.5	42.6	47.2
CBTA - 25M	25	19.9	34.9	38	31.3	26.5	36.8	49.1	55.6
CBTA - 28M	28	22.5	41.0	46	36.6	36.6	43.2	64.0	65.0

All dimensions are in millimeters unless otherwise specified. Dimensions are for reference only, subject to change.

Stub Tube Connector

Male Adapter CAM

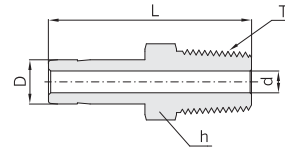

Hy-Lok Adapter eliminates difficult alignment problems.



1. It is required to install tubing to a female port in a certain direction as shown.

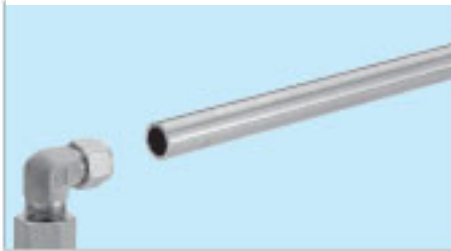

2. With pipe connection tight, the male elbow is directed to wrong direction.

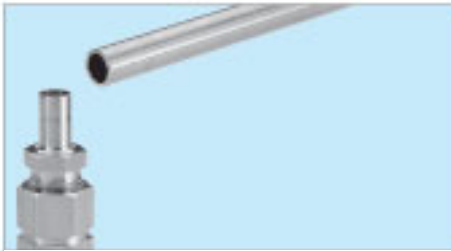

3. To avoid this, simply tighten the pipe thread of male adapter into female port.



4. Connect union elbow to male adapter by tightening the Hy-Lok nut while keeping the elbow in the desired direction. Then install the tubing into the other end of elbow.

Connects Fractional Hy-Lok Port To Female NPT Thread

Part No.	Tube O.D. D		T* (NPT)	d (mm)	Width across flat h		L
	in	mm			in	mm	
CAM 2 - 2N	1/8	3.17	1/8	2.03	7/16	11.11	29.50
CAM 2 - 4N	1/8	3.17	1/4	2.03	9/16	14.28	34.80
CAM 3 - 2N	3/16	4.76	1/8	3.04	7/16	11.11	30.22
CAM 3 - 4N	3/16	4.76	1/4	3.04	9/16	14.28	35.56
CAM 4 - 2N	1/4	6.35	1/8	4.32	7/16	11.11	31.80
CAM 4 - 4N	1/4	6.35	1/4	4.32	9/16	14.28	37.08
CAM 4 - 6N	1/4	6.35	3/8	4.32	11/16	17.46	37.84
CAM 4 - 8N	1/4	6.35	1/2	4.32	7/8	22.22	43.43
CAM 5 - 2N	5/16	7.93	1/8	4.57	7/16	11.11	32.76
CAM 5 - 4N	5/16	7.93	1/4	5.59	9/16	14.28	38.10
CAM 6 - 2N	3/8	9.52	1/8	4.83	7/16	11.11	33.50
CAM 6 - 4N	3/8	9.52	1/4	6.86	9/16	14.28	38.90
CAM 6 - 6N	3/8	9.52	3/8	6.86	11/16	17.46	39.60
CAM 6 - 8N	3/8	9.52	1/2	6.86	7/8	22.22	45.20
CAM 8 - 4N	1/2	12.70	1/4	7.11	9/16	14.28	44.50
CAM 8 - 6N	1/2	12.70	3/8	9.40	11/16	17.46	45.20
CAM 8 - 8N	1/2	12.70	1/2	9.40	7/8	22.22	50.50
CAM10 - 6N	5/8	15.87	3/8	9.65	11/16	17.46	47.40
CAM10 - 8N	5/8	15.87	1/2	11.94	7/8	22.22	52.30
CAM10 - 12N	5/8	15.87	3/4	11.94	1-1/16	26.98	52.30
CAM12 - 8N	3/4	19.05	1/2	11.94	7/8	22.22	52.30
CAM12 - 12N	3/4	19.05	3/4	14.73	1-1/16	26.98	52.30
CAM12 - 16N	3/4	19.05	1	14.73	1-3/8	34.92	57.91
CAM14 - 12N	7/8	22.22	3/4	15.75	1-1/16	26.98	54.30
CAM16 - 12N	1	25.40	3/4	15.75	1-1/16	26.98	58.70
CAM16 - 16N	1	25.40	1	20.32	1-3/8	34.92	66.00
CAM20 - 20N	1-1/4	31.75	1-1/4	25.91	1-3/4	44.45	80.26
CAM24 - 24N	1-1/2	38.10	1-1/2	31.75	2-1/8	53.97	94.48
CAM32 - 32N	2	50.80	2	43.69	2-3/4	69.85	119.38

* ISO Tapered Threads are available upon request.

Connects Metric Hy-Lok Port To Female ISO Taperad Thread

Part No.	Tube O.D. D	T* R(PT)	d Min.	Width across flat h	ℓ	L
CAM 6M - 2R	6	1/8	4.1	12	15.75	32.8
CAM 6M - 4R	6	1/4	4.1	14	15.75	38.1
CAM 8M - 4R	8	1/4	5.6	14	16.50	39.1
CAM10M - 4R	10	1/4	7.1	14	17.50	39.9
CAM10M - 6R	10	3/8	7.1	18	17.50	40.6
CAM10M - 8R	10	1/2	7.1	22	17.50	45.2
CAM12M - 4R	12	1/4	7.1	14	23.50	46.5
CAM12M - 6R	12	3/8	8.8	17	23.50	46.2
CAM12M - 8R	12	1/2	8.8	22	23.50	51.8
CAM18M - 8R	18	1/2	11.9	22	24.90	53.2
CAM18M - 12R	18	3/4	13.9	27	24.90	53.2
CAM28M - 16R	28	1	22.2	35	31.70	74.7
CAM28M - 20R	28	1-1/4	22.5	46	31.70	76.2
CAM32M - 20R	32	1-1/4	26.5	46	40.00	81.0
CAM38M - 24R	38	1-1/2	31.8	55	51.50	92.2

* NPT Threads are available upon request.

All dimensions are in millimeters unless otherwise specified. Dimensions are for reference only, subject to change.

Hy-Lok Two Ferrules Tube Fittings

Female Adapter CAF

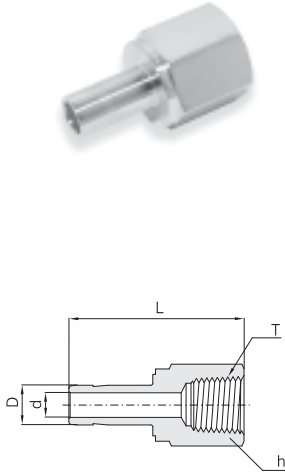

Connects Fractional Hy-Lok Port To Male NPT Thread

Part No.	Tube O.D. D		T* (NPT)	d Min.	Width across flat h		L
	in	mm			in	mm	
CAF 2 - 2N	1/8	3.17	1/8	2.03	9/16	14.28	31.50
CAF 2 - 4N	1/8	3.17	1/4	2.03	3/4	19.05	35.30
CAF 3 - 2N	3/16	4.76	1/8	3.04	9/16	14.28	32.00
CAF 3 - 4N	3/16	4.76	1/4	3.04	3/4	19.05	35.81
CAF 4 - 2N	1/4	6.35	1/8	4.32	9/16	14.28	33.02
CAF 4 - 4N	1/4	6.35	1/4	4.32	3/4	19.05	37.10
CAF 4 - 6N	1/4	6.35	3/8	4.32	7/8	22.22	39.37
CAF 4 - 8N	1/4	6.35	1/2	4.32	1-1/16	26.98	45.50
CAF 5 - 2N	5/16	7.93	1/8	5.59	9/16	14.28	34.29
CAF 5 - 4N	5/16	7.93	1/4	5.59	3/4	19.05	37.59
CAF 6 - 2N	3/8	9.52	1/8	6.86	9/16	14.28	34.29
CAF 6 - 4N	3/8	9.52	1/4	6.86	3/4	19.05	38.10
CAF 6 - 6N	3/8	9.52	3/8	6.86	7/8	22.22	40.38
CAF 6 - 8N	3/8	9.52	1/2	6.86	1-1/16	26.98	46.73
CAF 8 - 4N	1/2	12.70	1/4	9.40	3/4	19.05	43.43
CAF 8 - 6N	1/2	12.70	3/8	9.40	7/8	22.22	45.46
CAF 8 - 8N	1/2	12.70	1/2	9.40	1-1/16	26.98	51.80
CAF10 - 6N	5/8	15.87	3/8	11.94	7/8	22.22	48.26
CAF10 - 8N	5/8	15.87	1/2	11.94	1-1/16	26.98	53.84
CAF10 - 12N	5/8	15.87	3/4	11.94	1-5/16	33.33	55.37
CAF12 - 8N	3/4	19.05	1/2	14.73	1-1/16	26.98	52.83
CAF12 - 12N	3/4	19.05	3/4	14.73	1-5/16	33.33	54.86
CAF12 - 16N	3/4	19.05	1	14.73	1-5/8	41.27	58.42
CAF14 - 12N	7/8	22.22	3/4	15.75	1-5/16	33.33	57.15
CAF16 - 12N	1	25.40	3/4	20.32	1-5/16	33.33	60.70
CAF16 - 16N	1	25.40	1	20.32	1-5/8	41.27	64.26
CAF20 - 20N	1-1/4	31.75	1-1/4	25.91	2-1/8	53.97	77.72
CAF24 - 24N	1-1/2	38.10	1-1/2	31.75	2-3/8	60.32	88.90
CAF32 - 32N	2	50.80	2	43.69	2-7/8	70.02	107.44

* ISO Tapered Threads are available upon request.

Connects Metric Hy-Lok Port To Male ISO Tapered Thread

Part No.	Tube O.D. D	T* R(PT)	d Min.	Width across flat h	L
CAF 3M - 2R	3	1/8	1.9	14	31.15
CAF 6M - 2R	6	1/8	4.1	14	32.50
CAF 6M - 4R	6	1/4	4.1	19	37.10
CAF 8M - 4R	8	1/4	5.6	19	37.60
CAF10M - 4R	10	1/4	7.1	19	38.10
CAF10M - 6R	10	3/8	7.1	22	40.10
CAF10M - 8R	10	1/2	7.1	27	46.50
CAF12M - 4R	12	1/4	8.8	19	43.70
CAF12M - 6R	12	3/8	8.8	22	46.00
CAF12M - 8R	12	1/2	8.8	27	52.30
CAF18M - 12R	18	3/4	13.9	35	54.80

* NPT Threads are available upon request.

All dimensions are in millimeters unless otherwise specified. Dimensions are for reference only, subject to change.

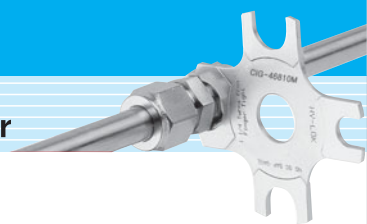

Male Adapter CAM-G

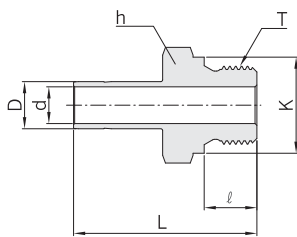

Connectors Fractional Hy-Lok Port To Female ISO Parallel Thread

Part No.	Tube O.D. D		T G(PF)	d min.	Width across flat h		ℓ	L	K
	in	mm			in	mm			
CAM 2 - 2G	1/8	3.17	1/8	2.03	9/16	14.28	7.11	30.99	13.72
CAM 2 - 4G	1/8	3.17	1/4	2.03	3/4	19.05	11.17	35.81	17.78
CAM 4 - 2G	1/4	6.35	1/8	4.06	9/16	14.28	7.11	33.27	13.72
CAM 4 - 4G	1/4	6.35	1/4	4.32	3/4	19.05	11.17	38.10	17.78
CAM 6 - 4G	3/8	9.52	1/4	5.84	3/4	19.05	11.17	39.88	17.78
CAM 6 - 6G	3/8	9.52	3/8	6.86	7/8	22.22	11.17	40.64	21.59
CAM 8 - 4G	1/2	12.70	1/4	5.84	3/4	19.05	11.17	45.47	17.78
CAM 8 - 6G	1/2	12.70	3/8	7.88	7/8	22.22	11.17	46.23	21.59
CAM 8 - 8G	1/2	12.70	1/2	9.40	1 1/16	26.98	14.22	49.28	25.91
CAM 12 - 12G	3/4	19.05	3/4	14.73	1 5/16	33.33	15.75	54.88	31.75
CAM 16 - 16G	1	25.40	1	20.32	1 5/8	41.27	18.29	64.52	38.86

Plugs unused port of metric Hy-Lok fittings.

Connectors Metric Hy-Lok Port To Female ISO Parallel Thread

Part No.	Tube O.D D	T G(PF)	d min.	Width across flat h	ℓ	L	K
CAM 6M - 2G	6	1/8	4.0	14	7.1	34.3	13.7
CAM 6M - 4G	6	1/4	4.1	19	11.2	39.1	17.9
CAM 8M - 4G	8	1/4	5.6	19	11.2	40.1	17.9
CAM 10M - 4G	10	1/4	5.9	19	11.2	40.9	17.9
CAM 10M - 6G	10	3/8	7.1	22	11.2	41.7	21.7
CAM 10M - 8G	10	1/2	7.1	27	14.2	44.7	25.9
CAM 12M - 4G	12	1/4	5.9	19	11.2	46.7	17.9
CAM 12M - 6G	12	3/8	7.9	22	11.2	47.2	21.7
CAM 12M - 8G	12	1/2	8.8	27	14.2	50.5	25.9
CAM 18M - 8G	18	1/2	11.9	27	14.2	52.1	25.9
CAM 18M - 12G	18	3/4	13.9	35	15.7	56.1	31.9
CAM 28M - 16G	28	1	19.8	41	18.3	72.9	39.0
CAM 28M - 20G	28	1 1/4	22.5	50	19.8	77.0	49.0
CAM 30M - 20G	30	1 1/4	24.3	50	19.8	80.8	49.0
CAM 32M - 20G	32	1 1/4	26.5	50	19.8	81.8	49.0
CAM 38M - 24G	38	1 1/2	31.6	55	22.1	94.5	54.7

Plugs unused port of metric Hy-Lok fittings.

SAE / MS Male Adapter CAM-U

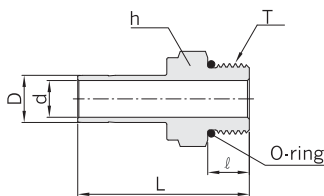

Connectors Fractional Hy-Lok Port To SAE / MS Straight Thread Boss

Part No.	Tube O.D. D		Straight Thread T(U)	d min.	Width across flat h		ℓ	L	O-ring Uniform Size Number
	in	mm			in	mm			
CAM 2 - 2U	1/8	3.17	5/16-24	2.03	7/16	11.11	7.62	30.48	-902
CAM 4 - 4U	1/4	6.35	7/16-20	4.32	9/16	14.28	9.14	35.31	-904
CAM 6 - 4U	3/8	9.52	7/16-20	5.08	9/16	14.28	9.14	37.08	-904
CAM 6 - 6U	3/8	9.52	9/16-18	6.86	11/16	17.46	9.90	38.61	-906
CAM 6 - 8U	3/8	9.52	3/4-16	6.86	7/8	22.22	11.17	40.64	-908
CAM 8 - 6U	1/2	12.7	9/16-18	7.11	11/16	17.46	9.90	44.19	-906
CAM 8 - 8U	1/2	12.7	3/4-16	9.40	7/8	22.22	11.17	46.23	-908
CAM 10 - 10U	5/8	15.87	7/8-14	11.94	1	25.40	12.70	49.27	-910
CAM 12 - 12U	3/4	19.05	1 1/16-12	14.73	1 1/4	31.75	14.98	53.34	-912
CAM 16 - 16U	1	25.40	1 5/16-12	20.32	1 1/2	38.10	14.98	61.21	-916
CAM 20 - 20U	1 1/4	31.75	1 5/8-12	25.91	1 7/8	47.62	14.98	71.37	-920
CAM 24 - 24U	1 1/2	38.10	1 7/8-12	31.75	2 1/8	53.97	14.98	83.31	-924
CAM 32 - 32U	2	50.80	2 1/2-12	43.69	2 3/4	69.85	14.98	107.44	-932

All dimensions are in millimeters unless otherwise specified. Dimensions are for reference only, subject to change.

Hy-Lok Two Ferrules Tube Fittings

O-Seal Straight Thread Male Adapter

CAMOS

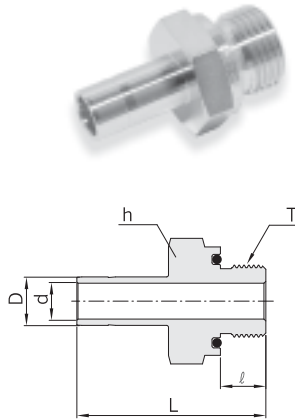

Connectors Fractional Hy-Lok Port To O-Seal Female Straight Thread

Part No.	Tube O.D. D		Straight Thread T(U)	d min.	Width across flat h		ℓ	L	O-ring Uniform Size Number
	in	mm			in	mm			
CAMOS 2 - 2U	1/8	3.17	5/16-24	2.03	9/16	14.28	8.63	32.51	-011
CAMOS 3 - 3U	1/8	3.17	3/8-24	3.05	5/8	15.87	9.65	35.05	-013
CAMOS 4 - 4U	1/4	6.35	7/16-20	4.32	3/4	19.05	10.41	39.11	-013
CAMOS 5 - 5U	5/16	7.93	1/2-20	5.59	7/8	22.22	11.18	41.65	-112
CAMOS 6 - 6U	3/8	9.52	9/16-18	6.86	15/16	23.81	11.94	43.18	-113
CAMOS 8 - 8U	1/2	12.70	3/4-16	9.40	1 1/8	28.57	11.94	49.53	-116

AN Adapter

CAMF

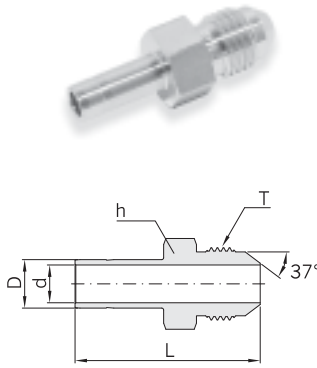

Connectors Fractional Hy-Lok Port To AN Flared Tube

Part No.	Tube O.D. D		AN Tube O.D. D		Straight Thread T(U)	d min.	Width across flat h		L
	in	mm	in	mm			in	mm	
CAMF 4 - 4	1/4	6.35	1/4	6.35	7/16-20	4.32	1/2	12.70	37.08
CAMF 6 - 4	3/8	9.52	1/4	6.35	7/16-20	4.32	1/2	12.70	38.86
CAMF 6 - 6	3/8	9.52	3/8	9.52	9/16-18	6.86	5/8	15.87	39.62
CAMF 8 - 8	1/2	12.70	1/2	12.70	3/4-16	9.40	13/16	20.63	48.51
CAMF 12 - 12	3/4	19.05	3/4	19.05	1 1/16-12	14.73	1 1/8	28.58	56.13
CAMF 16 - 16	1	25.40	1	25.40	1 5/16-12	20.32	1 3/8	34.92	65.53

Weld Adapter

SAPW

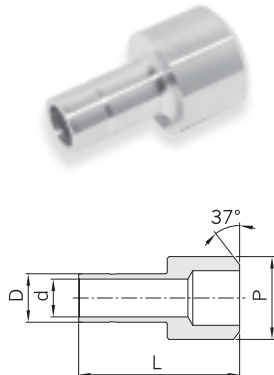

Connectors Fractional Hy-Lok Port To Pipe

Part No.	Tube O.D. D		Male Pipe Size P		d min.	L
	in	mm	Nom.	mm		
SAPW 4T - 4P	1/4	6.35	1/4	13.70	4.32	28.96
SAPW 6T - 8P	3/8	9.52	1/2	21.30	6.86	37.08
SAPW 8T - 8P	1/2	12.70	1/2	21.30	9.40	42.16
SAPW 8T - 12P	1/2	12.70	3/4	26.67	9.40	42.67
SAPW 12T - 12P	3/4	19.05	3/4	26.67	14.73	47.50

All dimensions are in millimeters unless otherwise specified. Dimensions are for reference only, subject to change.

Stub Tube Connector



Installation Instruction Port Connectors

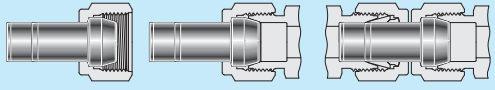

Fig.1 Fig.2 (1/4 turn) Fig.3 (1 1/4 turn)

Machined Ferrule End

While holding fitting body steady, tighten the port connector one-quarter turn from the finger-tight position. For 1/16", 1/8", and 3/16"; 2mm, 3mm and 4mm tube fittings, tighten the port connector one-eighth turn. For over 1in. and over 25mm tube fittings, tighten the port connector one quarter turn.

Reassembly

You may disassemble and reassemble Hy-Lok port connectors many times. Make subsequent connections by slightly tightening with a wrench after snugging the nut by hand.

Tube adapter End

1. Insert the tube adapter into the Hy-Lok two ferrule tube fittings until tubing end is firmly seated on the body shoulder and make sure the nut is hand tight. (Fig.3)
2. Mark the nut at 9 o'clock position for identification of starting point.
3. Tighten the nut 1 1/4 turns* with a wrench keeping the fitting body steady with a back-up wrench, when the nut is tightened 1 1/4 turns, the mark at 9 o'clock position before tightening will be at 12 o'clock position.

Note* : Only 3/4 turn from finger tight is required for 1/16", 1/8", 3/16", 2mm, 3mm, and 4mm sizes.

Reassembly

See Hy-Lok two ferrule tube fittings reassembly, page 71

Port Connector CPC

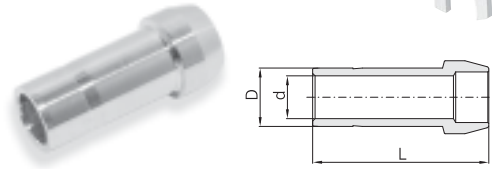

Connects Two Fractional Hy-Lok Ports

Part No.	Tube O.D. D		d Min.	L
	in	mm		
CPC - 1	1/16	1.58	0.76	13.72
CPC - 2	1/8	3.17	2.03	22.35
CPC - 4	1/4	6.35	4.32	24.89
CPC - 5	5/16	7.93	5.59	25.91
CPC - 6	3/8	9.52	6.86	26.67
CPC - 8	1/2	12.70	9.40	36.32
CPC - 12	3/4	19.05	14.73	37.85
CPC - 16	1	25.40	20.32	49.28

Connects Two Metric Hy-Lok Ports

Part No.	Tube O.D. D	d Min.	L
CPC - 3M	3	1.9	22.20
CPC - 4M	4	2.2	23.21
CPC - 6M	6	4.1	25.00
CPC - 8M	8	5.6	26.00
CPC - 10M	10	7.1	27.10
CPC - 12M	12	8.8	36.20
CPC - 15M	15	11.2	37.80
CPC - 16M	16	12.0	37.80
CPC - 18M	18	13.9	37.80
CPC - 20M	20	15.5	39.40
CPC - 22M	22	16.1	38.97
CPC - 25M	25	19.9	49.30
CPC - 28M	28	22.5	63.50
CPC - 32M	32	26.5	69.70
CPC - 38M	38	31.6	81.90

Reducing Port Connector CPR

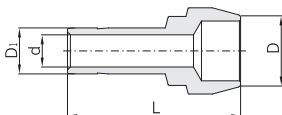

Connects Two Fractional Hy-Lok Ports

Part No.	Tube O.D. D		Reduced O.D. D ₁		d Min.	L
	in	mm	in	mm		
CPR 2 - 1	1/8	3.17	1/16	1.58	0.76	18.30
CPR 4 - 1	1/4	6.35	1/16	1.58	0.76	19.05
CPR 4 - 2	1/4	6.35	1/8	3.17	2.03	22.86
CPR 6 - 2	3/8	9.52	1/8	3.17	2.03	23.37
CPR 6 - 4	3/8	9.52	1/4	6.35	4.32	25.40
CPR 8 - 4	1/2	12.70	1/4	6.35	4.32	29.72
CPR 8 - 6	1/2	12.70	3/8	9.52	6.86	30.73
CPR 12 - 8	3/4	19.05	1/2	12.70	9.40	37.85
CPR 16 - 8	1	25.40	1/2	12.70	9.40	42.93
CPR 16 - 12	1	25.40	3/4	19.05	14.73	43.69

Connects Two Metric Hy-Lok Ports

Part No.	Tube O.D. D	Reduced O.D. D ₁	d Min.	L
CPR 6M - 3M	6	3	1.9	22.90
CPR 8M - 6M	8	6	4.1	25.40
CPR 10M - 6M	10	6	4.1	25.80
CPR 10M - 8M	10	8	5.6	26.30
CPR 12M - 6M	12	6	4.1	29.60
CPR 12M - 8M	12	8	5.6	30.10
CPR 12M - 10M	12	10	7.1	30.60
CPR 16M - 6M	16	6	4.1	29.37
CPR 16M - 12M	16	12	8.8	37.50
CPR 28M - 25M	28	25	19.9	56.50
CPR 32M - 25M	32	25	19.9	60.30
CPR 38M - 25M	38	25	19.9	65.80

All dimensions are in millimeters unless otherwise specified. Dimensions are for reference only, subject to change.

Hy-Lok Two Ferrules Tube Fittings

Lapped Flange Connector CFTC

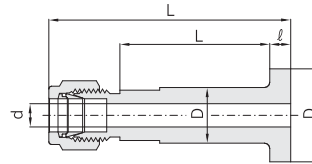

Hy-Lok Lapped flange connector provides safe and easy connections between process lines and instruments. It provides Hy-Lok tube connection ends by a lap joint pipe flange to ANSI B 16.5 or BS 1560. Both "smooth" and "serrated" surface finishes are available. For identification of serrated surface finish, groove is provided.

Part No.	Tube Size	Flange Seal	Dimensions						Flange Surface Finish (Ra)
			L	L ₁	l	D	D ₁	d min	
CFTC 4 - SM	1/4"	SM	80.8	56.5	6.5	35	22.2	4.8	3.2 - 6.3 Micrometer
CFTC 4 - SE	1/4"	SE	80.8	56.5	6.5	35	22.2	4.8	6.3 - 12.5 Micrometer
CFTC 6 - SM	3/8"	SM	82.3	56.5	6.5	35	22.2	7.1	3.2 - 6.3 Micrometer
CFTC 6 - SE	3/8"	SE	82.3	56.5	6.5	35	22.2	7.1	6.3 - 12.5 Micrometer
CFTC 8 - SM	1/2"	SM	84.8	56.5	6.5	35	22.2	10.4	3.2 - 6.3 Micrometer
CFTC 8 - SE	1/2"	SE	84.8	56.5	6.5	35	22.2	10.4	6.3 - 12.5 Micrometer

Surface Finish

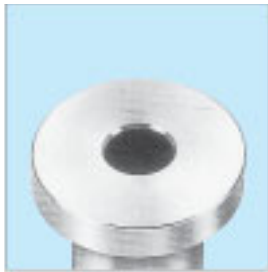

Smooth (SM)



Serrated (SE)

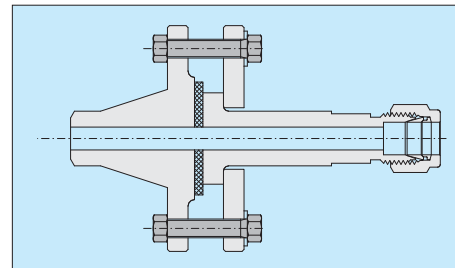

Lapped flange connector installed with gasket between seal faces

All dimensions are in millimeters unless otherwise specified. Dimensions are for reference only, subject to change.

Flange Connector

Integral ANSI Flange Connector CIAF

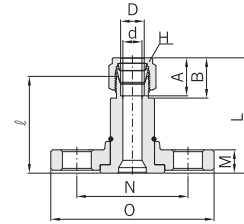

Connects Fractional Tubes

Part No.	Tube O.D. D		ANSI Flange NPS	ANSI Class	d min	H Width across flat		A	B	M	N	l	L	O
	in	mm				in	mm							
CIAF 8- 8F -R	1/2	12.70	1/2	150	10.41	7/8	22.22	22.86	21.84	15.7	60.5	52.7	62.72	88.9
CIAF 8- 8G -R	1/2	12.70	1/2	300	10.41	7/8	22.22	22.86	21.84	22.4	66.5	62.2	72.22	95.3
CIAF12- 8F -R	3/4	19.05	1/2	150	15.74	1-1/8	28.57	24.38	21.84	15.7	60.5	62.2	72.22	88.9
CIAF12- 8G -R	3/4	19.05	1/2	300	15.74	1-1/8	28.57	24.38	21.84	22.4	66.5	62.2	72.22	95.3
CIAF12-12F -R	3/4	19.05	3/4	150	15.74	1-1/8	28.57	24.38	21.84	15.7	69.9	53.0	62.99	98.6
CIAF12-12G -R	3/4	19.05	3/4	300	15.74	1-1/8	28.57	24.38	21.84	25.4	82.6	62.2	72.22	117.3
CIAF12-12I -R	3/4	19.05	3/4	600	15.74	1-1/8	28.57	24.38	21.84	25.4	82.6	67.5	77.72	117.3
CIAF12-16F -R	3/4	19.05	1	150	15.74	1-1/8	28.57	24.38	21.84	17.5	79.2	54.3	64.29	108.0
CIAF12-16G -R	3/4	19.05	1	300	15.74	1-1/8	28.57	24.38	21.84	26.9	88.9	63.8	73.82	124.0
CIAF16-12F -R	1	25.40	3/4	150	22.35	1-1/2	38.10	31.24	26.41	15.7	69.9	54.9	67.06	98.6
CIAF16-16F -R	1	25.40	1	150	22.35	1-1/2	38.10	31.24	26.41	17.5	79.2	56.5	68.76	108.0
CIAF16-16G -R	1	25.40	1	300	22.35	1-1/2	38.10	31.24	26.41	26.9	88.9	66.0	78.26	124.0
CIAF16-16I -R	1	25.40	1	600	22.35	1-1/2	38.10	31.24	26.41	26.9	88.9	73.5	85.76	124.0
CIAF16-24G -R	1	25.40	1 1/2	300	22.35	1-1/2	38.10	31.24	26.41	30.2	114.3	73.0	85.26	155.4

Pressure-Temperature Ratings

Ratings are taken from ASME B16.5-2003, Table 2-2.2 and Table F2-2.2

Pressure ratings for fittings with a flange end connection and another end connection are determined by the connection with the lower pressure rating.

Working Pressure by Classes, bar

Temperature °C	ASME Class						
	150	300	400	600	900	1500	2500
-29 to 38	19.0	49.6	66.2	99.3	148.9	248.2	413.7
50	18.4	48.1	64.2	96.2	144.3	240.6	400.9
100	16.2	42.2	56.3	84.4	126.6	211.0	351.6
150	14.8	38.5	51.3	77.0	115.5	192.5	320.8
200	13.7	35.7	47.6	71.3	107.0	178.3	297.2
250	12.1	33.4	44.5	66.8	100.1	166.9	278.1
300	10.2	31.6	42.2	63.2	94.9	158.1	263.5
325	9.3	30.9	41.2	61.8	92.7	154.4	257.4
350	8.4	30.3	40.4	60.7	91.0	151.6	252.7
375	7.4	29.9	39.8	59.8	89.6	149.4	249.0
400	6.5	29.4	39.3	58.9	88.3	147.2	245.3
425	5.5	29.1	38.9	58.3	87.4	145.7	242.9
450	4.6	28.8	38.5	57.7	86.5	144.2	240.4
475	3.7	28.7	38.2	57.3	86.0	143.4	238.9
500	2.8	28.2	37.6	56.5	84.7	140.9	235.0
538	1.4	25.2	33.4	50.0	75.2	125.5	208.9

Working Pressure by Classes, psig

Temperature °F	ASME Class						
	150	300	400	600	900	1500	2500
-20 to 100	275	720	960	1440	2160	3600	6000
200	235	620	825	1240	1860	3095	5160
300	215	560	745	1120	1680	2795	4660
400	195	515	685	1025	1540	2570	4280
500	170	480	635	955	1435	2390	3980
600	140	450	600	900	1355	2255	3760
650	125	440	590	885	1325	2210	3680
700	110	435	580	870	1305	2170	3620
750	95	425	570	855	1280	2135	3560
800	80	420	565	845	1265	2110	3520
850	65	420	555	835	1255	2090	3480
900	50	415	555	830	1245	2075	3460
950	35	385	515	775	1160	1930	3220
1000	20	365	485	725	1090	1820	3030

All dimensions are in millimeters unless otherwise specified. Dimensions are for reference only, subject to change.

AN Union
CFU

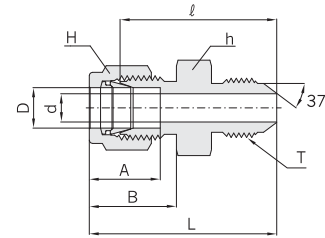

Connects Fractional Tube To AN Flared Tube

Part No.	Tube O.D. D		*AN Tube Flare Size		Straight Thread T(U)	d Min.	Width across flat				A	B	ℓ	L
	in	mm	in	mm			h		H					
							in	mm	in	mm				
CFU 1 - 2	1/16	1.58	1/8	3.17	5/16-24	1.27	7/16	11.11	5/16	7.93	8.63	10.92	23.36	27.17
CFU 2 - 2	1/8	3.17	1/8	3.17	5/16-24	1.52	7/16	11.11	7/16	11.11	12.70	15.24	24.89	31.49
CFU 2 - 4	1/8	3.17	1/4	6.35	7/16-20	2.28	1/2	12.70	7/16	11.11	12.70	15.24	28.44	35.05
CFU 4 - 4	1/4	6.35	1/4	6.35	7/16-20	4.31	1/2	12.70	9/16	14.28	15.24	17.78	30.22	37.59
CFU 5 - 5	5/16	7.93	5/16	7.93	1/2-20	5.84	9/16	14.28	5/8	15.87	16.25	18.54	30.98	38.35
CFU 6 - 4	3/8	9.52	1/4	6.35	7/16-20	4.31	5/8	15.87	11/16	17.46	16.76	19.30	32.25	39.62
CFU 6 - 6	3/8	9.52	3/8	9.52	9/16-18	7.11	5/8	15.87	11/16	17.46	16.76	19.30	32.25	39.62
CFU 8 - 8	1/2	12.70	1/2	12.70	3/4-16	9.90	13/16	20.63	7/8	22.22	22.86	21.84	35.81	45.97
CFU12 - 12	3/4	19.05	3/4	19.05	1-1/16-12	15.49	1-1/8	28.57	1-1/8	28.57	24.38	21.84	43.18	53.34
CFU16 - 16	1	25.40	1	25.40	1-5/16-12	21.33	1-3/8	34.92	1-1/2	38.10	31.24	26.41	49.27	61.46

AN Bulkhead Union
CBFU

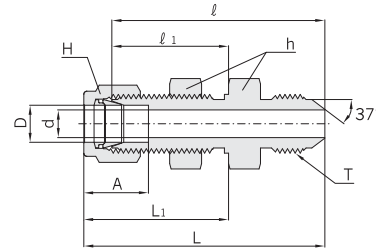

Connects Fractional Tube To AN Flared Tube

Part No.	Tube O.D. D		*AN Tube Flare Size		Straight Thread T(U)	d Min.	Width across flat				A	ℓ	ℓ ₁	L	L ₁	Panel Hole Drill Size	Panel Max. Thickness
	in	mm	in	mm			h		H								
							in	mm	in	mm							
CBFU 4 - 4	1/4	6.35	1/4	6.35	7/16-20	4.31	5/8	15.87	9/16	14.28	15.24	46.48	26.16	53.84	33.52	11.50	10.16
CBFU 6 - 6	3/8	9.52	3/8	9.52	9/16-18	7.11	3/4	19.05	11/16	17.46	16.76	49.78	29.46	57.15	36.83	14.68	11.17
CBFU 8 - 8	1/2	12.70	1/2	12.70	3/4-16	9.90	15/16	23.81	7/8	22.22	22.86	55.62	31.75	65.78	41.91	19.44	12.70
CBFU12 - 12	3/4	19.05	3/4	19.05	1-1/16-12	15.49	1-3/16	30.16	1-1/8	28.57	24.38	68.83	37.33	78.99	47.49	25.79	16.76
CBFU16 - 16	1	25.40	1	25.40	1-5/16-12	21.33	1-5/8	41.27	1-1/2	38.10	31.24	80.26	45.21	92.45	57.40	33.73	19.05

AN Adapter
CFA

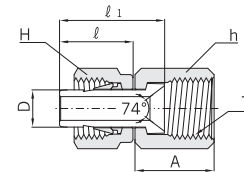

Connects Fractional Hy-Lok Port To Male AN

Part No.	Tube O.D. D		*AN Tube O.D.		Straight Thread T(U)	Width across flat				A	ℓ	ℓ ₁
	in	mm	in	mm		h		H				
						in	mm	in	mm			
CFA 2 - 2	1/8	3.17	1/8	3.17	5/16 - 24	3/8	9.52	7/16	11.11	13.71	13.46	18.54
CFA 2 - 4	1/8	3.17	1/4	6.35	7/16 - 20	9/16	14.28	7/16	11.11	15.74	13.46	19.05
CFA 4 - 4	1/4	6.35	1/4	6.35	7/16 - 20	9/16	14.28	9/16	14.28	15.74	15.74	21.33
CFA 6 - 6	3/8	9.52	3/8	9.52	9/16 - 18	11/16	17.46	11/16	17.46	18.28	17.52	24.89
CFA 8 - 8	1/2	12.70	1/2	12.70	3/4 - 16	7/8	22.22	7/8	22.22	21.59	23.11	31.75

* From Air Force and Navy Standard for 37 degree flared fittings (SAE J514)

All dimensions are in millimeters unless otherwise specified. Dimensions are for reference only, subject to change.



Adjustable SAE/MS Straight Thread Fittings

These adjustable or positionable fittings are useful in that the direction of Hy-Lok two ferrule tube fittings end can be oriented into desired direction with ease. they can be installed on tanks or vessels without welding or brazing. Viton O-ring is standard, and other materials are available upon request.

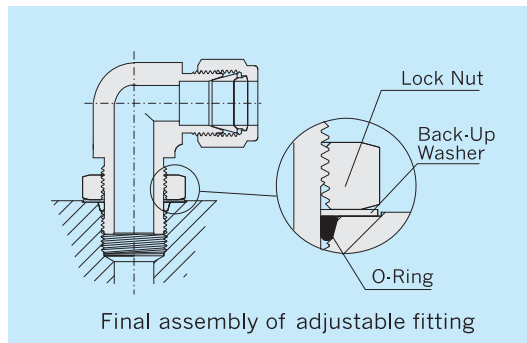

Installation Instructions

1. Lubricate O-ring with lubricant compatible with system and O-ring material and place it over the groove close to metal back-up washer.
3. Position the fitting by backing it out no more than one turn.

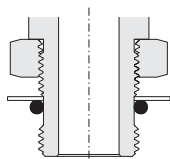

Fig. 1 - Lock Nut Backed Off

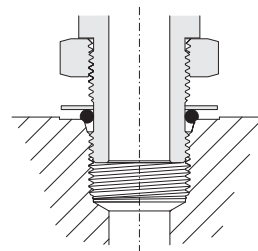

Fig. 3 - Fitting Backed Off for Alignment (1 Turn Maximum)

2. Screw fitting into the SAE straight thread boss until the washer contacts the face of the boss.

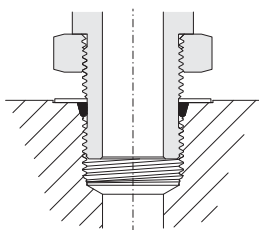

Fig. 2 - Fitting Installed Hight

4. Hold the fitting in position and tighten the lock nut until the washer contacts the face of the boss.

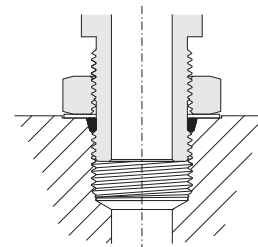
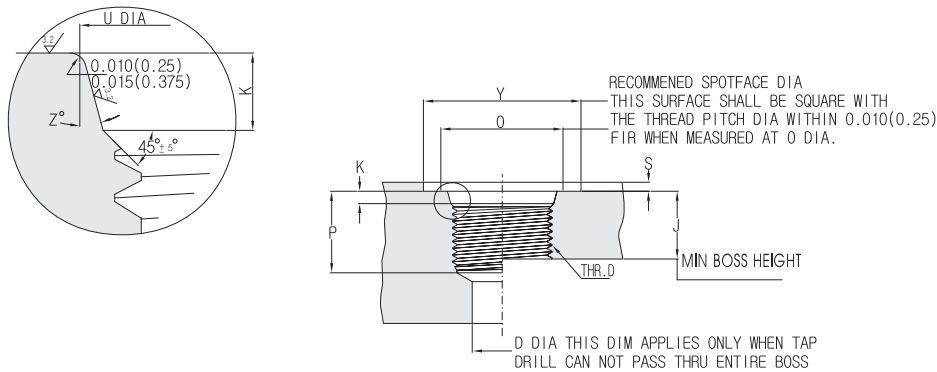

Fig. 4 - Fitting Lock Nut Tightened to Appropriate Torque

All dimensions are in millimeters unless otherwise specified. Dimensions are for reference only, subject to change.

Hy-Lok Two Ferrules Tube Fittings

SAE / MS Internal Straight Thread Boss



Data for SAE / MS Straight thread Boss

(reprinted from 'Hydraulic Tube Fittings-SAE J1926 / 1 Port Dimensions of SAE Standard.')

Nom Tube O.D.	Thread Size	D Min.	J Min.	K	O Min.	P Min.	U	Y	S Max.	Z
1/8	5/16 - 24	1.6	10.0	1.9	11	12.0	9.1	17	1.6	12°
3/16	3/8 - 24	3.2	10.0	1.9	13	12.0	10.7	19	1.6	12°
1/4	7/16 - 20	4.4	11.5	2.4	15	14.0	12.4	21	1.6	12°
5/16	1/2 - 20	6.0	11.5	2.4	16	14.0	14.0	23	1.6	12°
3/8	9/16 - 18	7.5	12.7	2.5	18	15.5	15.6	25	1.6	12°
1/2	3/4 - 16	10.0	14.3	2.5	22	17.5	20.6	30	2.4	15°
5/8	7/8 - 14	12.5	16.7	2.5	26	20.0	23.9	34	2.4	15°
3/4	1-1/16 - 12	16.0	19.0	3.3	32	23.0	29.2	41	2.4	15°
7/8	1-3/16 - 12	18.0	19.0	3.3	35	23.0	32.3	45	2.4	15°
1	1-5/16 - 12	21.0	19.0	3.3	38	23.0	35.5	49	3.2	15°
1 1/4	1-5/8 - 12	27.0	19.0	3.3	48	23.0	43.5	58	3.2	15°
1 1/2	1-7/8 - 12	33.0	19.0	3.3	54	23.0	49.8	65	3.2	15°
2	2-1/2 - 12	70.0	19.0	3.3	70	23.0	65.7	88	3.2	15°

- Diameter U shall be concentric with thread pitch diameter within 0.13 full indicator reading(FIR), and shall be free from longitudinal and spiral tool marks. Angular tool marks up to 2.5 Micro meter max. shall be permissible.
- Maximum recommended spotface depth to permit sufficient wrench grip for proper tightening of the fitting or locknut.
- If face of boss is on a machined surface, dimensions Y and S need not apply as long as R 0.25/0.375 is maintained to avoid damage to the O-Ring during installaton.
- Tap drill depths given require use of a bottoming taps to produce the specified full thread lengths. Where standard taps are used, the tap drill depths must be increased accordingly.
- Figures are for reference only, as any boss can be used for a tubing size depending upon other design criteria.

O - Ring Dimensions for SAE / MS Bosses

Standard O-Ring is Viton other materials are available upon request.

Part Size	Nominal Tube O.D.	Uniform Size Number	Dimension		Part Size	Nominal Tube O.D.	Uniform Size Number	Dimension	
			I.D. in	Cross Section in				I.D. in	Cross Section in
2	1/8	902	.239	.064	12	3/4	912	.924	.116
3	3/16	903	.301	.064	14	7/8	914	1.048	.116
4	1/4	904	.351	.072	16	1	916	1.171	.116
5	5/16	905	.414	.072	20	1-1/4	920	1.475	.118
6	3/8	906	.468	.078	24	1-1/2	924	1.720	.118
8	1/2	908	.644	.087	32	2	932	2.337	.118
10	5/8	910	.755	.097					

All dimensions are in millimeters unless otherwise specified. Dimensions are for reference only, subject to change.

Tube To SAE / MS O-Ring

SAE / MS Male Connector CSC

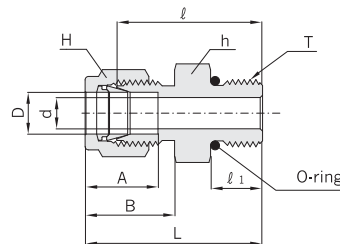

Connects Fractional Tube To SAE / MS Straight Thread Boss

Part No.	Tube O.D. D		Straight Thread T(U)	d Min.	Width across flat				A	B	l	l ₁	L	O-Ring Uniform Size Number
	in	mm			h	H								
					in	mm	in	mm						
CSC 2- 2U	1/8	3.17	5/16-24	2.28	7/16	11.11	7/16	11.11	12.70	15.24	23.26	7.62	29.97	-902
CSC 2- 4U	1/8	3.17	7/16-20	2.28	9/16	14.28	7/16	11.11	12.70	15.24	24.89	9.14	31.49	-904
CSC 4- 4U	1/4	6.35	7/16-20	4.82	9/16	14.28	9/16	14.28	15.24	17.78	26.67	9.14	34.03	-904
CSC 4- 6U	1/4	6.35	9/16-18	4.82	11/16	17.46	9/16	14.28	15.24	17.78	28.19	9.90	35.56	-906
CSC 4- 8U	1/4	6.35	3/4-16	4.82	7/8	22.22	9/16	14.28	15.24	17.78	30.22	11.17	37.59	-908
CSC 4-10U	1/4	6.35	7/8-14	4.82	1	25.40	9/16	14.28	15.24	17.78	33.27	12.70	40.64	-910
CSC 5- 5U	5/16	7.93	1/2-20	5.84	5/8	15.87	5/8	15.87	16.25	18.54	27.43	9.14	34.79	-905
CSC 6- 4U	3/8	9.52	7/16-20	5.08	5/8	15.87	11/16	17.46	16.76	19.30	28.19	9.14	35.56	-904
CSC 6- 6U	3/8	9.52	9/16-18	7.11	11/16	17.46	11/16	17.46	16.76	19.30	29.71	9.90	37.08	-906
CSC 6- 8U	3/8	9.52	3/4-16	7.11	7/8	22.22	11/16	17.46	16.76	19.30	31.75	11.17	39.11	-908
CSC 6-10U	3/8	9.52	7/8-14	7.11	1	25.40	11/16	17.46	16.76	19.30	34.79	12.70	42.16	-910
CSC 8- 6U	1/2	12.70	9/16-18	7.11	13/16	20.63	7/8	22.22	22.86	21.84	28.95	9.90	39.11	-906
CSC 8- 8U	1/2	12.70	3/4-16	10.41	7/8	22.22	7/8	22.22	22.86	21.84	31.75	11.17	41.91	-908
CSC 8-10U	1/2	12.70	7/8-14	10.41	1	25.40	7/8	22.22	22.86	21.84	34.79	12.70	44.95	-910
CSC 8-12U	1/2	12.70	1-1/16-12	10.41	1-1/4	31.75	7/8	22.22	22.86	21.84	38.86	14.98	49.02	-912
CSC10- 8U	5/8	15.87	3/4-16	10.66	15/16	23.81	1	25.40	24.38	21.84	31.75	11.17	41.91	-908
CSC10-10U	5/8	15.87	7/8-14	12.70	1	25.40	1	25.40	24.38	21.84	35.05	12.70	45.21	-910
CSC12- 8U	3/4	19.05	3/4-16	10.66	1-1/16	26.98	1-1/8	28.57	24.38	21.84	35.81	11.17	45.97	-908
CSC12-12U	3/4	19.05	1-1/16-12	15.74	1-1/4	31.80	1-1/8	28.57	24.38	21.84	38.86	14.98	49.02	-912
CSC14-14U	7/8	22.22	1-3/16-12	18.28	1-3/8	34.92	1-1/4	31.75	25.90	21.84	38.86	14.98	49.02	-914
CSC16-12U	1	25.40	1-1/16-12	16.76	1-3/8	34.92	1-1/2	38.10	31.24	26.41	41.14	14.98	53.34	-912
CSC16-16U	1	25.40	1-5/16-12	22.35	1-1/2	38.10	1-1/2	38.10	31.24	26.41	42.16	14.98	54.35	-916
CSC20-20U	1-1/4	31.75	1-5/8-12	27.68	1-7/8	47.62	1-7/8	47.62	41.14	38.86	46.22	14.98	68.32	-920
CSC24-24U	1-1/2	38.10	1-7/8-12	34.03	2-1/8	53.97	2-1/4	57.15	50.03	45.21	50.54	14.98	77.72	-924
CSC32-32U	2	50.80	2-1/2-12	45.97	2-3/4	69.85	3	76.20	67.56	62.73	64.26	14.98	101.60	-932

Positionable Male Elbow CSLA

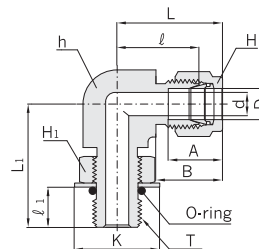

Connects Fractional Tube To SAE / MS Straight Thread Boss

Part No.	Tube O.D. D		Straight Thread T(U)	d Min.	Width across flat						A	B	l	l ₁	L	L ₁	K	O-Ring Uniform Size Number
	in	mm			h	H		H ₁										
					in	mm	in	mm	in	mm								
CSLA 4- 4U	1/4	6.35	7/16-20	4.82	1/2	12.70	9/16	14.28	9/16	14.28	15.24	17.78	21.08	9.90	28.44	28.44	16.51	-904
CSLA 4- 6U	1/4	6.35	9/16-18	4.82	5/8	15.87	9/16	14.28	11/16	17.46	15.24	17.78	23.11	11.17	30.48	32.25	20.06	-906
CSLA 5- 5U	5/16	7.93	1/2-20	5.84	9/16	14.28	5/8	15.87	5/8	15.87	16.25	18.54	22.86	9.90	30.22	29.46	18.28	-905
CSLA 6- 6U	3/8	9.52	9/16-18	7.11	5/8	15.87	11/16	17.46	11/16	17.46	16.76	19.30	24.63	11.17	32.00	32.25	20.06	-906
CSLA 6- 8U	3/8	9.52	3/4-16	7.11	13/16	20.63	11/16	17.46	7/8	22.22	16.76	19.30	27.43	12.70	34.79	37.84	25.65	-908
CSLA 8- 8U	1/2	12.70	3/4-16	10.41	13/16	20.63	7/8	22.22	7/8	22.22	22.86	21.84	27.43	12.70	37.59	37.84	25.65	-908
CSLA10-10U	5/8	15.87	7/8-14	12.70	1	25.40	1	25.40	1	25.40	24.38	21.84	29.46	14.22	39.62	43.43	29.46	-910
CSLA12-12U	3/4	19.05	1-1/16-12	15.74	1-1/16	26.98	1-1/8	28.57	1-1/4	31.75	24.38	21.84	31.24	16.76	41.40	48.76	36.57	-912
CSLA14-14U	7/8	22.22	1-3/16-12	18.28	1-1/4	31.75	1-1/4	31.75	1-3/8	34.92	25.90	21.84	33.02	16.76	43.18	50.54	40.38	-914
CSLA16-16U	1	25.40	1-5/16-12	22.35	1-3/8	34.92	1-1/2	38.10	1-1/2	38.10	31.24	26.41	38.35	16.76	50.54	53.59	43.94	-916
CSLA20-20U	1-1/4	31.75	1-5/8-12	27.68	1-11/16	42.86	1-7/8	47.62	1-7/8	47.62	41.14	38.86	45.72	16.76	67.81	58.16	54.86	-920
CSLA24-24U	1-1/2	38.10	1-7/8-12	34.03	2	50.80	2-1/4	57.15	2-1/8	53.97	50.03	45.21	50.80	16.76	77.97	60.45	62.23	-924
CSLA32-32U	2	50.80	2-1/2-12	45.97	2-3/4	69.85	3	76.20	2-3/4	69.85	67.56	62.73	69.85	16.76	107.18	71.62	80.26	-932

All dimensions are in millimeters unless otherwise specified. Dimensions are for reference only, subject to change.

Hy-Lok Two Ferrules Tube Fittings

Positionable Male Elbow CSLA

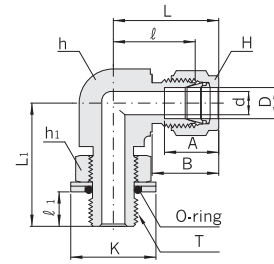

Connects Metric Tube To Female ISO Parallel Thread

Part NO.	Tube O.D D		T G(PF)	d min	Width across flat			A	B	ℓ	ℓ ₁	L	L ₁	K	O-ring Uniform Size Number
	in	mm			h	h ₁	H								
CSLA 6M- 2G	6	6.35	1/8	4.0	12.7	14.2	14	15.3	17.7	19.6	8.1	27.0	26.4	15.2	P8
CSLA 6M- 4G	6	6.35	1/4	4.8	15.8	19.1	14	15.3	17.7	21.6	9.1	29.0	32.3	20.3	-111
CSLA 8M- 2G	8	8.00	1/8	4.0	14.2	14.2	16	16.2	18.6	21.3	8.1	28.8	27.4	15.2	P8
CSLA 8M- 4G	8	8.00	1/4	5.9	15.8	19.1	16	16.2	18.6	22.4	9.1	29.9	32.2	20.3	-111
CSLA10M- 4G	10	10.00	1/4	5.9	20.6	19.1	19	17.2	19.5	25.9	9.1	33.5	35.0	20.3	-111
CSLA10M- 6G	10	10.00	3/8	7.9	20.6	22.2	19	17.2	19.5	25.9	9.4	33.5	37.1	24.4	-113
CSLA12M- 4G	12	12.00	1/4	5.9	20.6	19.1	22	22.8	22.0	25.9	9.1	36.0	35.0	20.3	-111
CSLA12M- 6G	12	12.00	3/8	7.9	20.6	22.2	22	22.8	22.0	25.9	9.4	36.0	37.1	24.4	-113
CSLA12M- 8G	12	12.00	1/2	9.5	23.8	26.9	22	22.8	22.0	27.9	13.0	38.0	43.4	32.0	P18
CSLA12M-12G	12	12.00	3/4	9.5	26.9	34.9	22	22.8	22.0	29.7	13.0	39.8	48.8	36.3	-119

Positionable Male Run Tee CSRT

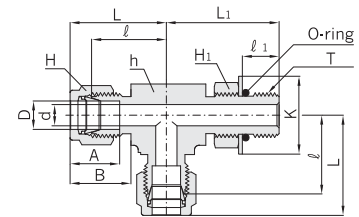

Connects Fractional Tube To SAE / MS Straight Thread Boss

Part No.	Tube O.D. D		Straight Thread T(U)	d Min.	Width across flat						A	B	ℓ	ℓ ₁	L	L ₁	K	O-Ring Uniform Size Number
	in	mm			h		H		H ₁									
	in	mm			in	mm	in	mm	in	mm								
CSRT 4- 4U	1/4	6.35	7/16-20	4.82	1/2	12.70	9/16	14.28	9/16	14.28	15.24	17.78	21.08	9.90	28.44	28.44	16.51	-904
CSRT 6- 6U	3/8	9.52	9/16-18	7.11	5/8	15.87	11/16	17.46	11/16	17.46	16.76	19.03	24.63	11.17	32.00	32.25	20.06	-906
CSRT 8- 8U	1/2	12.70	3/4-16	10.41	13/16	20.63	7/8	22.22	7/8	22.22	22.86	21.84	27.43	12.70	37.59	37.84	25.65	-908
CSRT12-12U	3/4	19.05	1-1/16-12	15.74	1-1/8	28.57	1-1/8	28.57	1-1/4	28.57	24.38	21.84	31.24	16.76	41.40	48.76	36.57	-912
CSRT16-16U	1	25.40	1-5/16-12	22.35	1-3/8	34.92	1-1/2	38.10	1-1/2	38.10	31.24	26.41	38.35	16.76	50.54	50.54	43.94	-916
CSRT20-20U	1-1/4	31.75	1-5/8-12	27.68	1-11/16	42.86	1-7/8	47.62	1-7/8	47.62	41.14	38.86	45.72	16.76	67.81	58.16	54.86	-920
CSRT24-24U	1-1/2	38.10	1-7/8-12	34.03	2	50.80	2-1/4	57.15	2-1/8	53.97	50.03	45.21	50.80	16.76	77.97	60.45	62.23	-924
CSRT32-32U	2	50.80	2-1/2-12	45.97	2-3/4	69.85	3	76.20	2-3/4	69.85	67.56	62.73	69.85	16.76	107.18	71.62	80.26	-932

Positionable Male Branch Tee CSBT

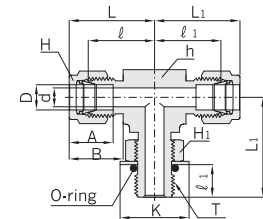

Connects Fractional Tube To SAE / MS Straight Thread Boss

Part No.	Tube O.D. D		Straight Thread T(U)	d Min.	Width across flat						A	B	ℓ	ℓ ₁	L	L ₁	K	O-Ring Uniform Size Number
	in	mm			h		H		H ₁									
	in	mm			in	mm	in	mm	in	mm								
CSBT 4- 4U	1/4	6.35	7/16-20	4.82	1/2	12.70	9/16	14.28	9/16	14.28	15.24	17.78	21.08	9.90	28.44	28.44	16.51	-904
CSBT 6- 6U	3/8	9.52	9/16-18	7.11	5/8	15.87	11/16	17.46	11/16	17.46	16.76	19.03	24.63	11.17	32.00	32.25	20.06	-906
CSBT 8- 8U	1/2	12.70	3/4-16	10.41	13/16	20.63	7/8	22.22	7/8	22.22	22.86	21.84	27.43	12.70	37.59	37.84	25.65	-908
CSBT12-12U	3/4	19.05	1-1/16-12	15.74	1-1/8	28.57	1-1/8	28.57	1-1/4	28.57	24.38	21.84	31.24	16.76	41.40	48.76	36.57	-912
CSBT16-16U	1	25.40	1-5/16-12	22.35	1-3/8	34.92	1-1/2	38.10	1-1/2	38.10	31.24	26.41	38.35	16.76	50.54	50.54	43.94	-916
CSBT20-20U	1-1/4	31.75	1-5/8-12	27.68	1-11/16	42.86	1-7/8	47.62	1-7/8	47.62	41.14	38.86	45.72	16.76	67.81	58.16	54.86	-920
CSBT24-24U	1-1/2	38.10	1-7/8-12	34.03	2	50.80	2-1/4	57.15	2-1/8	53.97	50.03	45.21	50.80	16.76	77.97	60.45	62.03	-924
CSBT32-32U	2	50.80	2-1/2-12	45.97	2-3/4	69.85	3	76.20	2-3/4	69.85	67.56	62.73	69.85	16.76	107.18	71.62	80.26	-932

All dimensions are in millimeters unless otherwise specified. Dimensions are for reference only, subject to change.

Tube To SAE / MS O-Ring

Positionable 45° Male Elbow

CSLB

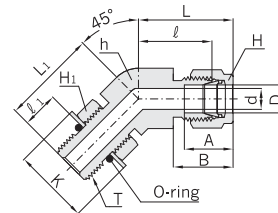

Connects Fractional Tube To SAE / MS Straight Thread Boss

Part No.	Tube O.D. D		Straight Thread T(U)	d Min.	Width across flat						A	B	l	l ₁	L	L ₁	K	O-Ring Uniform Size Number
	in	mm			h		H		H ₁									
					in	mm	in	mm										
CSLB 4- 4U	1/4	6.35	7/16-20	4.82	1/2	12.70	9/16	14.28	9/16	14.28	15.24	17.78	18.28	9.90	25.65	25.65	16.51	-904
CSLB 6- 6U	3/8	9.52	9/16-18	7.11	5/8	15.87	11/16	17.46	11/16	17.46	16.76	19.30	20.57	11.17	27.94	28.19	20.06	-906
CSLB 8- 8U	1/2	12.70	3/4-16	10.41	13/16	20.63	7/8	22.22	7/8	22.22	22.86	21.84	21.84	12.70	32.00	32.25	25.65	-908
CSLB12-12U	3/4	19.05	1-1/16-12	15.74	1-1/8	28.57	1-1/8	28.57	1-1/4	31.75	24.38	21.84	29.71	16.76	39.87	47.24	36.57	-912
CSLB16-16U	1	25.40	1-5/16-12	22.35	1-3/8	34.92	1-1/2	38.10	1-1/2	38.10	31.24	26.41	35.30	16.76	47.49	50.54	43.94	-916

O-Seal Straight Thread Connector

COS

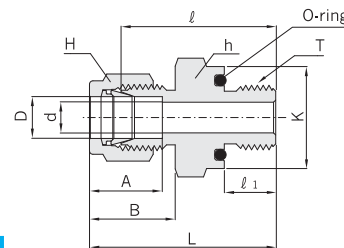

Connects Fractional Tube To Female Straight Thread.

Part No.	Tube O.D. D		Straight Thread T(U)	d Min.	Width across flat						A	B	l	l ₁	L	K	O-Ring Uniform Size Number
	in	mm			h		H		H ₁								
					in	mm	in	mm									
COS 2- 2U	1/8	3.17	5/16-24	2.28	9/16	14.28	7/16	11.11	12.70	15.24	26.16	8.63	32.76	13.97	-011		
COS 3- 3U	3/16	4.76	3/8-24	3.04	5/8	15.87	1/2	12.70	13.71	16.00	27.68	9.65	34.29	15.75	-012		
COS 4- 4U	1/4	6.35	7/16-20	4.82	3/4	19.05	9/16	14.28	15.24	17.78	30.98	10.41	38.35	18.80	-111		
COS 5- 5U	5/16	7.93	1/2-20	6.35	7/8	22.22	5/8	15.87	16.25	18.54	33.27	11.17	40.64	21.84	-112		
COS 6- 6U	3/8	9.52	9/16-18	7.11	15/16	23.81	11/16	17.46	16.76	19.30	35.05	11.93	42.41	23.62	-113		
COS 8- 8U	1/2	12.70	3/4-16	10.41	1-1/8	28.57	7/8	22.22	22.86	21.84	35.81	11.93	45.97	28.45	-116		
COS12-12U	3/4	19.05	1-1/16-12	15.74	1-1/2	38.10	1-1/8	28.57	24.38	21.84	42.16	14.22	52.32	37.85	-215		
COS16-16U	1	25.40	1-5/16-12	22.35	1-3/4	44.45	1-1/2	38.10	31.24	26.41	45.97	14.22	58.16	44.20	-219		

O-Seal Pipe Thread Connector

COP

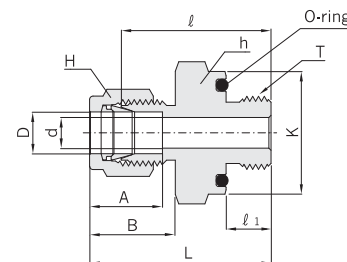

Connects Fractional Tube To Female NPT Thread.

Part No.	Tube O.D. D		Straight Thread T*(NPT)	d Min.	Width across flat						A	B	l	l ₁	L	K	O-Ring Uniform Size Number
	in	mm			h		H		H ₁								
					in	mm	in	mm									
COP2 - 2	1/8	3.17	1/8	2.28	3/4	19.05	7/16	11.11	12.70	15.24	26.16	7.11	32.76	18.80	-111		
COP4 - 2	1/4	6.35	1/8	4.82	3/4	19.05	9/16	14.28	15.24	17.78	27.68	7.11	35.05	18.80	-111		
COP4 - 4	1/4	6.35	1/4	4.82	15/16	23.81	9/16	14.28	15.24	17.78	30.98	9.65	38.35	23.62	-113		
COP6 - 4	3/8	9.52	1/4	7.11	15/16	23.81	11/16	17.46	16.76	19.30	32.51	9.65	39.87	23.62	-113		
COP6 - 6	3/8	9.52	3/8	7.11	1-1/8	28.57	11/16	17.46	16.76	19.30	34.03	10.41	41.40	28.45	-116		
COP6 - 8	3/8	9.52	1/2	7.11	1-5/16	33.33	11/16	17.46	16.76	19.30	39.62	13.46	46.99	33.02	-212		
COP8 - 8	1/2	12.70	1/2	10.41	1-5/16	33.33	7/8	22.22	22.86	21.84	39.62	13.46	49.78	33.02	-212		

* ISO Parallel Threads are available upon request.

All dimensions are in millimeters unless otherwise specified. Dimensions are for reference only, subject to change.

Hy-Lok Two Ferrules Tube Fittings

O-Seal Connectors

Hy-Lok O-seal Fittings can be directly installed into existing pipe thread or straight thread port.

Due to short thread length, thread interference which is common on tapered thread does not occur and the leak tight seal is made by O-ring.

The standard Viton O-ring is fully contained in a precision groove, The groove provides antiextrusion of O-ring at high pressure and controlled squeeze for vacuum tight sealing.

To provide a leak tight installation, smooth flat surface perpendicular to the axis of the threads is required.

Installation Instructions

1. Hand tighten the O-Seal fittings in the port until O-ring compresses on the port.
2. Snug the fitting with wrench.

Note : When installing or disconnecting tubing to or from Hy-Lok tube end, make sure that the fitting body is always held by back-up wrench, By doing this, the fitting does not turn and the proper seal is maintained.

The illustrations and table below show required mounting dimensions for O-seal connectors.

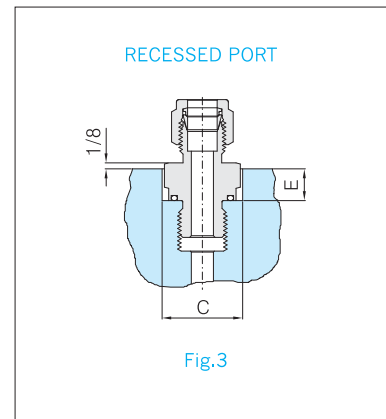
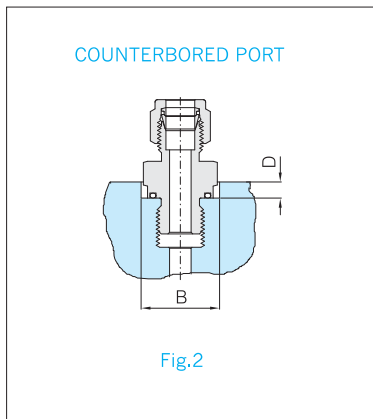
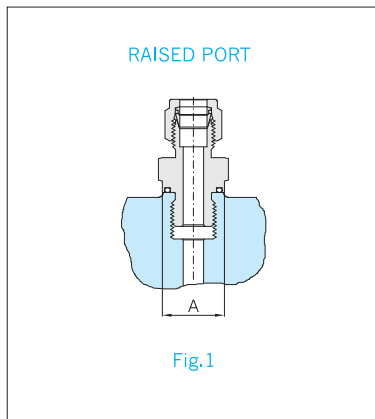

Mounting Dimensions

Port No.	Straight Thread	Pipe Thread	A Min.	B Min.	C Min.	D Min.	E Min.
COS 2 - 2	5/16-24	-	12.7	15.0	16.8	2.3	5.6
COP 2 - 2	-	1/8 NPT	17.5	19.8	22.4	4.1	7.1
COS 3 - 3	3/8-24	-	14.2	16.8	19.1	2.3	5.6
COS 4 - 4	7/16-20	-	17.5	19.8	22.4	4.1	7.1
COP 4 - 2	-	1/8 NPT	17.5	19.8	22.4	4.1	7.1
COP 4 - 4	-	1/4 NPT	22.1	24.6	27.7	4.1	7.9
COS 5 - 5	1/2-20	-	19.1	23.1	26.2	4.1	7.9
COS 6 - 6	9/16-18	-	20.6	24.6	27.7	4.1	7.9
COP 6 - 6	-	1/8 NPT	25.4	29.5	33.3	4.1	8.6
COP 6 - 8	-	1/2 NPT	31.0	34.0	38.9	5.6	11.2
COS 8 - 8	3/4-16	-	25.4	29.5	33.3	4.1	8.6
COP 8 - 8	-	1/2 NPT	31.0	34.0	38.9	5.6	11.2
COS12 - 12	1-1/16-12	-	35.8	38.9	44.5	5.6	12.7
COS16 - 16	1-5/16-12	-	42.9	45.2	51.6	5.6	14.2

All dimensions are in millimeters unless otherwise specified. Dimensions are for reference only, subject to change.



Male Pipe Weld Connector
CWC

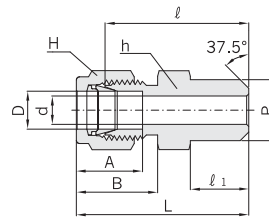

Connects Fractional Tube To Pipe

Part No.	Tube O.D.		Male Pipe Size P		d Min.	Width across flat				A	B	l	l ₁	L
	in	mm	Nom.	O.D.		h		H						
						in	mm	in	mm					
CWC 2 - 2P	1/8	3.17	1/8	10.30	2.28	7/16	11.11	7/16	11.11	12.70	15.24	23.87	9.65	31.24
CWC 3 - 2P	3/16	4.76	1/8	10.30	3.04	7/16	11.11	1/2	12.70	13.71	16.00	24.63	9.65	31.24
CWC 4 - 2P	1/4	6.35	1/8	10.30	4.82	1/2	12.70	9/16	14.28	15.24	17.78	25.40	9.65	32.76
CWC 4 - 4P	1/4	6.35	1/4	13.70	4.82	9/16	14.28	9/16	14.28	15.24	17.78	30.48	14.22	37.84
CWC 5 - 2P	5/16	7.93	1/8	10.30	5.08	9/16	14.28	5/8	15.87	16.25	18.54	26.67	9.65	34.03
CWC 5 - 4P	5/16	7.93	1/4	13.70	6.35	9/16	14.28	5/8	15.87	16.25	18.54	31.24	14.22	38.60
CWC 6 - 4P	3/8	9.52	1/4	13.70	7.11	5/8	15.87	11/16	17.46	16.76	19.30	32.51	14.22	39.87
CWC 6 - 6P	3/8	9.52	3/8	17.10	7.11	11/16	17.46	11/16	17.46	16.76	19.30	32.51	14.22	39.87
CWC 6 - 8P	3/8	9.52	1/2	21.30	7.11	7/8	22.22	11/16	17.46	16.76	19.30	38.86	19.05	43.23
CWC 6 - 12P	3/8	9.52	3/4	26.67	7.11	1-1/16	26.98	11/16	17.46	16.76	19.30	40.38	19.05	47.75
CWC 8 - 6P	1/2	12.70	3/8	17.10	10.41	13/16	20.63	7/8	22.22	22.86	21.84	33.27	14.22	43.43
CWC 8 - 8P	1/2	12.70	1/2	21.30	10.41	7/8	22.22	7/8	22.22	22.86	21.84	38.86	19.05	49.02
CWC 8 - 12P	1/2	12.70	3/4	26.67	10.41	1-1/16	26.98	7/8	22.22	22.86	21.84	40.38	19.05	50.54
CWC 10 - 8P	5/8	15.87	1/2	21.30	12.70	15/16	23.81	1	25.40	24.38	21.84	38.86	19.05	49.02
CWC 12 - 12P	3/4	19.05	3/4	26.67	15.74	1-1/16	26.98	1-1/8	28.57	24.38	21.84	40.38	19.05	50.54
CWC 16 - 16P	1	25.40	1	33.40	22.35	1-3/8	34.92	1-1/2	38.10	31.24	26.41	50.03	23.87	62.23
CWC 20 - 20P	1-1/4	31.75	1-1/4	42.16	27.68	1-3/4	44.45	2	50.80	41.14	38.86	55.11	23.87	77.21
CWC 24 - 24P	1-1/2	38.10	1-1/2	48.26	34.03	2-1/8	53.97	2-1/4	57.15	50.03	45.21	61.72	26.16	88.90
CWC 32 - 32P	2	50.80	2	60.32	47.75	2-3/4	69.85	3	76.20	67.56	62.73	76.20	26.92	113.53

Connects Metric Tube To Pipe

Part No.	Tube O.D.	Male Pipe Size P		d Min.	Width across flat		A	B	l	l ₁	L
		Nom.	O.D.		h	H					
CWC 4M - 2P	4	1/8	10.3	2.4	12	12	13.7	16.1	24.1	9.7	30.7
CWC 6M - 2P	6	1/8	10.3	4.8	14	14	15.3	17.7	25.4	9.7	32.8
CWC 6M - 4P	6	1/4	13.7	4.8	14	14	15.3	17.7	30.2	14.2	37.6
CWC 8M - 2P	8	1/8	10.3	5.1	15	16	16.2	18.6	26.7	9.7	34.2
CWC 8M - 4P	8	1/4	13.7	6.4	15	16	16.2	18.6	31.2	14.2	38.7
CWC 8M - 8P	8	1/2	21.3	6.4	22	16	16.2	18.6	37.3	19.0	44.8
CWC 10M - 4P	10	1/4	13.7	7.1	18	19	17.2	19.5	33.3	14.2	40.9
CWC 10M - 6P	10	3/8	17.1	7.9	18	19	17.2	19.5	33.3	14.2	40.1
CWC 10M - 8P	10	1/2	21.3	7.9	22	19	17.2	19.5	38.1	19.0	45.7
CWC 12M - 4P	12	1/4	13.7	7.1	22	22	22.8	22.0	33.3	14.2	43.4
CWC 12M - 6P	12	3/8	17.1	9.5	22	22	22.8	22.0	33.3	14.2	43.4
CWC 12M - 8P	12	1/2	21.3	9.5	22	22	22.8	22.0	38.1	19.0	48.2
CWC 14M - 6P	14	3/8	17.1	10.3	24	25	24.4	22.0	34.0	14.2	44.1
CWC 15M - 8P	15	1/2	21.3	11.9	24	25	24.4	22.0	38.9	19.0	49.0
CWC 16M - 8P	16	1/2	21.3	12.7	24	25	24.4	22.0	38.9	19.0	49.0
CWC 18M - 8P	18	1/2	21.3	13.5	27	30	24.4	22.0	40.4	19.0	50.5
CWC 32M - 20P	32	1-1/4	42.2	28.6	46	50	42.0	41.6	56.6	23.9	79.6
CWC 38M - 24P	38	1-1/2	48.3	33.7	55	60	49.4	47.9	64.0	26.2	91.6

Note : All Hy-Lok pipe weld ends have schedule 80 wall thickness or greater.

Welding Precautions

- If you weld the fully assembled fittings, the assembly can be distorted and the lubricant on the nut can be removed, which is not desirable.
- To avoid this, remove nut and ferrules from the body and cover thread and seat area with another nut or a plug in order to protect them from weld splatter. (Jsut finger tighten for easy removal)
- Provide a proper heat sink for heat dissipation.
- After welding, replace the nut and ferrules.

All dimensions are in millimeters unless otherwise specified. Dimensions are for reference only, subject to change.

Hy-Lok Two Ferrules Tube Fittings

Male Pipe Weld Elbow CLW

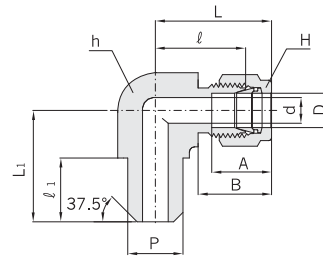

Connects Fractional Tube To Pipe

Part No.	Tube O.D. D		Pipe Weld Size P		d Min.	Width across flat				A	B	ℓ	ℓ ₁	L	L ₁
	in	mm	Nom.	O.D.		h		H							
						in	mm	in	mm						
CLW 2 - 2P	1/8	3.17	1/8	10.30	4.82	1/2	12.70	9/16	14.28	15.24	17.78	19.55	9.65	26.92	18.79
CLW 4 - 4P	1/4	6.35	1/4	13.70	4.82	1/2	12.70	9/16	14.28	15.24	17.78	19.55	14.22	26.92	23.36
CLW 6 - 4P	3/8	9.52	1/4	13.70	7.11	5/8	15.87	11/16	17.46	16.76	19.30	23.11	14.22	30.48	25.40
CLW 8 - 8P	1/2	12.70	1/2	21.30	10.41	13/16	20.63	7/8	22.22	22.86	21.84	25.90	19.05	36.06	33.02
CLW12 - 12P	3/4	19.05	3/4	26.67	15.74	1-1/16	26.98	1-1/8	28.57	24.38	21.84	29.71	19.05	39.87	36.83

Tube Socket Weld Connector CSWC

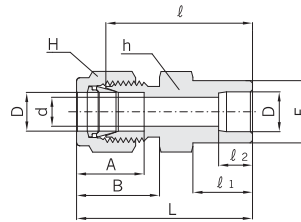

Connects Fractional Tubes

Part No.	Tube O.D. D		d Min.	E	Width across flat				A	B	ℓ	ℓ ₁	ℓ ₂	L
	in	mm			h		H							
					in	mm	in	mm						
CSWC 2 - 2	1/8	3.17	2.28	7.87	7/16	11.11	7/16	11.11	12.70	15.24	22.35	8.63	6.35	28.95
CSWC 4 - 4	1/4	6.35	4.82	11.17	1/2	12.70	9/16	14.28	15.24	17.78	26.16	10.41	7.87	33.52
CSWC 6 - 6	3/8	9.52	7.11	15.74	5/8	15.87	11/16	17.46	16.76	19.30	30.22	11.93	9.65	37.59
CSWC 8 - 8	1/2	12.70	10.41	19.05	13/16	20.63	7/8	22.22	22.86	21.84	30.98	11.93	12.70	41.14
CSWC12 - 12	3/4	19.05	15.74	26.67	1-1/16	26.98	1-1/8	28.57	24.38	21.84	33.27	11.93	14.22	43.43
CSWC16 - 16	1	25.40	22.35	33.27	1-3/8	34.92	1-1/2	38.10	31.24	26.41	40.38	14.22	19.05	52.57

Tube Socket Weld Elbow CLSW

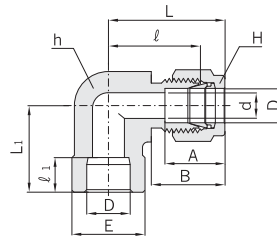

Connects Fractional Tubes

Part No.	Tube O.D. D		d Min.	E	Width across flat				A	B	ℓ	ℓ ₁	L	L ₁
	in	mm			h		H							
					in	mm	in	mm						
CLSW 4 - 4	1/4	6.35	4.82	12.70	1/2	12.70	9/16	14.28	15.24	17.78	19.55	7.87	26.92	19.55
CLSW 6 - 6	3/8	9.52	7.11	15.74	5/8	15.87	11/16	17.46	16.76	19.30	23.11	9.65	30.48	23.11
CLSW 8 - 8	1/2	12.70	10.41	20.57	13/16	20.63	7/8	22.22	22.86	21.84	25.90	12.70	36.06	25.90
CLSW12 - 12	3/4	19.05	15.74	26.92	1-1/16	26.98	1-1/8	28.57	24.38	21.84	29.71	14.22	39.87	29.71
CLSW16 - 16	1	25.40	22.35	35.05	1-3/8	34.92	1-1/2	38.10	31.24	26.41	36.83	19.05	49.02	36.83

All dimensions are in millimeters unless otherwise specified. Dimensions are for reference only, subject to change.



Weld Union CBUW

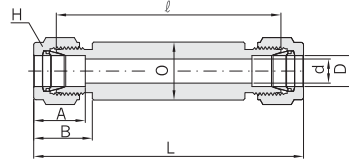

Connects Fractional Tubes

Part No.	Tube O.D D		d min	H Width across flat		A	B	l	L	O
	in	mm		in	mm					
CBUW - 1	1/16	1.58	1.27	5/16	7.93	8.63	10.92	64.2	71.84	10.00
CBUW - 2	1/8	3.17	2.28	7/16	11.11	12.70	15.24	67.2	80.48	12.00
CBUW - 3	3/16	4.76	3.04	1/2	12.70	13.71	16.00	69.0	82.00	12.00
CBUW - 4	1/4	6.35	4.82	9/16	14.28	15.24	17.78	70.4	85.56	14.00
CBUW - 5	5/16	7.93	6.35	5/8	15.87	16.25	18.54	73.7	87.08	16.00
CBUW - 6	3/8	9.52	7.11	11/16	17.46	16.76	19.30	73.7	88.60	19.00
CBUW - 8	1/2	12.70	10.41	7/8	22.22	22.86	21.84	73.7	93.68	23.00
CBUW - 10	5/8	15.87	12.70	1	25.40	24.38	21.84	73.7	93.68	28.00
CBUW - 12	3/4	19.05	15.74	1-1/8	28.57	24.38	21.84	73.7	93.68	32.00
CBUW - 14	7/8	22.22	18.28	1-1/4	31.75	25.90	21.84	73.7	93.68	32.00
CBUW - 16	1	25.40	22.35	1-1/2	38.10	31.24	26.41	78.5	102.82	35.00
CBUW - 20	1 1/4	31.75	27.68	1-7/8	47.62	41.14	38.86	83.9	127.72	50.00
CBUW - 24	1 1/2	38.10	34.03	2-1/4	57.15	50.03	45.21	86.1	140.42	55.00
CBUW - 32	2	50.80	45.97	3	76.20	67.56	62.73	100.9	175.46	80.00

Connects Metric Tubes

Part No.	Tube O.D D	d min	H Width across flat	A	B	l	L	O
CBUW - 2M	2	1.7	12	12.9	15.3	67.3	80.3	12.0
CBUW - 3M	3	2.4	12	12.9	15.3	67.3	80.3	12.0
CBUW - 4M	4	2.4	12	13.7	16.1	69.0	82.2	12.0
CBUW - 6M	6	4.8	14	15.3	17.7	70.4	85.4	12.0
CBUW - 8M	8	6.4	15	16.2	18.6	72.1	87.2	16.0
CBUW - 10M	10	7.9	18	17.2	19.5	73.7	89.0	19.0
CBUW - 12M	12	9.5	22	22.8	22.0	73.7	94.0	23.0
CBUW - 15M	15	11.9	24	24.4	22.0	73.7	94.0	25.0
CBUW - 16M	16	12.7	24	24.4	22.0	73.7	94.0	28.0
CBUW - 18M	18	15.1	27	24.4	22.0	73.7	94.0	28.0
CBUW - 20M	20	15.9	30	26.0	22.0	73.7	94.0	32.0
CBUW - 22M	22	18.3	30	26.0	22.0	73.7	94.0	32.0
CBUW - 25M	25	21.8	35	31.3	26.5	78.6	102.5	38.0
CBUW - 28M	28	21.8	41	36.6	36.6	81.7	122.2	45.0
CBUW - 32M	32	28.6	46	42.0	41.6	87.1	133.2	50.0
CBUW - 38M	38	33.7	55	49.4	47.9	90.9	145.8	60.0

* Specified length to be shown as last designator in part number
Example : CBUW-8L100

Thermocouple Weld Union CBUWT

Bore Through weld union handle thermocouple or dip tubes with ease. For correct part number, just add "T" as suffix to CBUW, the weld union designator.
Example : CBUWT-8-S316 1/2" tube stainless steel 316

All dimensions are in millimeters unless otherwise specified. Dimensions are for reference only, subject to change.

Weld Half Union
CHBUW

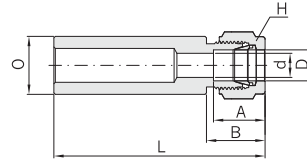

Connects Fractional Tubes

Part No.	Tube O.D D		d min	H Width across flat		A	B	L	O
	in	mm		in	mm				
CHBUW - 1	1/16	1.58	1.27	5/16	7.93	8.63	10.92	60.92	10.00
CHBUW - 2	1/8	3.17	2.28	7/16	11.11	12.70	15.24	65.24	12.00
CHBUW - 3	3/16	4.76	3.04	1/2	12.70	13.71	16.00	76.00	12.00
CHBUW - 4	1/4	6.35	4.82	9/16	14.28	15.24	17.78	67.78	14.00
CHBUW - 5	5/16	7.93	6.35	5/8	15.87	16.25	18.54	68.54	16.00
CHBUW - 6	3/8	9.52	7.11	11/16	17.46	16.76	19.30	69.30	19.00
CHBUW - 8	1/2	12.70	10.41	7/8	22.22	22.86	21.84	71.84	23.00
CHBUW - 10	5/8	15.87	12.70	1	25.40	24.38	21.84	71.84	28.00
CHBUW - 12	3/4	19.05	15.74	1-1/8	28.57	24.38	21.84	71.84	32.00
CHBUW - 14	7/8	22.22	18.28	1-1/4	31.75	25.90	21.84	71.84	32.00
CHBUW - 16	1	25.40	22.35	1-1/2	38.10	31.24	26.41	76.41	35.00
CHBUW - 20	1 1/4	31.75	27.68	1-7/8	47.62	41.14	38.86	88.86	50.00
CHBUW - 24	1 1/2	38.10	34.03	2-1/4	57.15	50.03	45.21	95.21	55.00
CHBUW - 32	2	50.80	45.97	3	76.20	67.56	62.73	112.73	80.00

Connects Metric Tubes

Part No.	Tube O.D D	d min	H Width across flat	A	B	L	O
CHBUW - 2M	2	1.7	12	12.9	15.3	65.3	12.0
CHBUW - 3M	3	2.4	12	12.9	15.3	65.3	12.0
CHBUW - 4M	4	2.4	12	13.7	16.1	66.1	12.0
CHBUW - 6M	6	4.8	14	15.3	17.7	67.7	12.0
CHBUW - 8M	8	6.4	15	16.2	18.6	68.6	16.0
CHBUW - 10M	10	7.9	18	17.2	19.5	69.5	19.0
CHBUW - 12M	12	9.5	22	22.8	22.0	72.0	23.0
CHBUW - 15M	15	11.9	24	24.4	22.0	72.0	25.0
CHBUW - 16M	16	12.7	24	24.4	22.0	72.0	28.0
CHBUW - 18M	18	15.1	27	24.4	22.0	72.0	28.0
CHBUW - 20M	20	15.9	30	26.0	22.0	72.0	32.0
CHBUW - 22M	22	18.3	30	26.0	22.0	72.0	32.0
CHBUW - 25M	25	21.8	35	31.3	26.5	76.5	38.0
CHBUW - 28M	28	21.8	41	36.6	36.6	86.6	45.0
CHBUW - 32M	32	28.6	46	42.0	41.6	91.6	50.0
CHBUW - 38M	38	33.7	55	49.4	47.9	97.9	60.0

* Specified length to be shown as last designator in part number
Example : CHBUW-4L100

Thermocouple Weld Half Union
CHBUWT

Bore Through weld union handle thermocouple or dip tubes with ease. For correct part number, just add "T" as a suffix to CHBUW, the weld half union designator.

Example : CHBUWT-8-S316 1/2" tube stainless steel 316

All dimensions are in millimeters unless otherwise specified. Dimensions are for reference only, subject to change.



Plug for Hy-Lok Port CPA

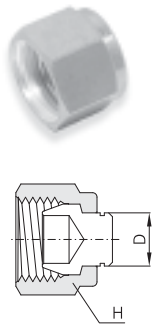

Installation Instruction
With wrench, 1/4 turn from finger-tight position.
(1/8 turn for 1/8", 3/16" and 2mm, 3mm, 4mm
size plug, 1/2 turn for over 1" and 25mm)

Connects Fractional Hy-Lok Port

Part No.	Tube O.D. D		Width across flat H	
	in	mm	in	mm
CPA - 1	1/16	1.58	5/16	7.94
CPA - 2	1/8	3.17	7/16	11.11
CPA - 3	3/16	4.76	1/2	12.70
CPA - 4	1/4	6.35	9/16	14.28
CPA - 5	5/16	7.93	5/8	15.87
CPA - 6	3/8	9.52	11/16	17.46
CPA - 8	1/2	12.70	7/8	22.22
CPA - 10	5/8	15.87	1	25.40
CPA - 12	3/4	19.05	1-1/8	28.57
CPA - 14	7/8	22.22	1-1/4	31.75
CPA - 16	1	25.40	1-1/2	38.10
CPA - 20	1-1/4	31.75	1-7/8	47.62
CPA - 24	1-1/2	38.10	2-1/4	57.15
CPA - 32	2	50.80	3	76.20

Plugs unused port of metric Hy-Lok fittings.

Connects Metric Hy-Lok Port

Part No.	Tube O.D. D	Width across flat H	Part No.	Tube O.D. D	Width across flat H
CPA - 2M	2	12	CPA - 16M	16	25
CPA - 3M	3	12	CPA - 18M	18	30
CPA - 4M	4	12	CPA - 20M	20	32
CPA - 6M	6	14	CPA - 22M	22	32
CPA - 8M	8	16	CPA - 25M	25	38
CPA - 10M	10	19	CPA - 28M	28	46
CPA - 12M	12	22	CPA - 32M	32	50
CPA - 15M	15	25	CPA - 38M	38	60

Plugs unused port of fractional Hy-Lok fittings.

Cap for Tube End CCA

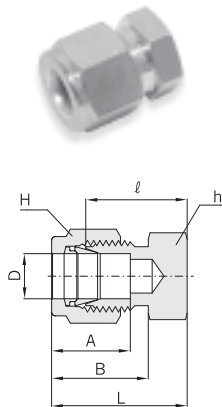

Installation Instruction

Follow Hy-Lok installation instruction on page 51

Connects Fractional Tube End

Part No.	Tube O.D. D		Width across flat				A	B	ℓ	L
	in	mm	h		H					
CCA - 1	1/16	1.58	5/16	7.94	5/16	7.94	8.63	10.92	11.20	14.18
CCA - 2	1/8	3.17	7/16	11.11	7/16	11.11	12.70	15.24	13.46	20.06
CCA - 3	3/16	4.76	7/16	11.11	1/2	12.70	13.71	16.00	14.73	21.33
CCA - 4	1/4	6.35	1/2	12.70	9/16	14.28	15.24	17.78	16.00	23.26
CCA - 5	5/16	7.93	9/16	14.28	5/8	15.87	16.25	18.54	17.01	24.38
CCA - 6	3/8	9.52	5/8	15.87	11/16	17.46	16.76	19.30	18.28	25.65
CCA - 8	1/2	12.70	13/16	20.63	7/8	22.22	22.86	21.84	19.05	29.21
CCA - 10	5/8	15.87	15/16	23.81	1	25.40	24.38	21.84	19.81	29.97
CCA - 12	3/4	19.05	1-1/16	26.98	1-1/8	28.57	24.38	21.84	21.33	31.49
CCA - 14	7/8	22.22	1-3/16	30.16	1-1/4	31.75	25.90	21.84	23.87	34.03
CCA - 16	1	25.40	1-3/8	34.92	1-1/2	38.10	31.24	26.41	26.16	38.35
CCA - 20	1-1/4	31.75	1-3/4	44.45	1-7/8	47.62	41.14	38.86	31.24	53.34
CCA - 24	1-1/2	38.10	2-1/8	53.97	2-1/4	57.15	50.03	45.21	37.33	64.51
CCA - 32	2	50.80	2-3/4	69.85	3	76.20	67.56	62.73	49.27	86.61

Connects Metric Tube End

Part No.	Tube O.D. D	Width across flat		A	B	ℓ	L
		h	H				
CCA - 2M	2	12	12	12.9	15.3	13.5	20.1
CCA - 3M	3	12	12	12.9	15.3	13.5	20.1
CCA - 4M	4	12	12	13.7	16.1	14.7	21.3
CCA - 6M	6	14	14	15.3	17.7	15.7	23.1
CCA - 8M	8	15	16	16.2	18.6	17.0	24.5
CCA - 10M	10	18	19	17.2	19.5	19.0	26.6
CCA - 12M	12	22	22	22.8	22.0	19.0	29.1
CCA - 15M	15	24	25	24.4	22.0	19.8	29.9
CCA - 16M	16	24	25	24.4	22.0	19.8	29.9
CCA - 18M	18	27	30	24.4	22.0	21.3	31.4
CCA - 20M	20	30	32	26.0	22.0	23.9	34.0
CCA - 22M	22	30	32	26.0	22.0	23.9	34.0
CCA - 25M	25	35	38	31.3	26.5	26.2	38.5
CCA - 28M	28	41	46	36.6	36.6	27.7	48.5
CCA - 32M	32	46	50	42.0	41.6	32.8	55.8
CCA - 38M	38	55	60	49.4	47.9	37.8	65.4

All dimensions are in millimeters unless otherwise specified. Dimensions are for reference only, subject to change.

Hy-Lok Two Ferrules Tube Fittings

Union CRMTU

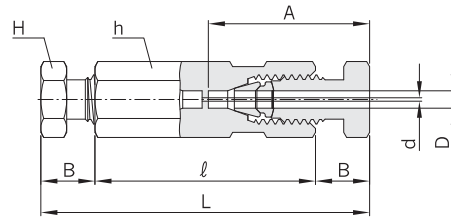

Low Dead Volume Union

Part No.	Tube O.D. D		d Min.	Width across flat				A	B	l	L
	in	mm		h		H					
				in	mm	in	mm				
CRMTU - 1	1/16	1.58	0.33	1/4	6.35	1/4	6.35	15.49	5.08	21.34	31.75

Union Tee CRMTT

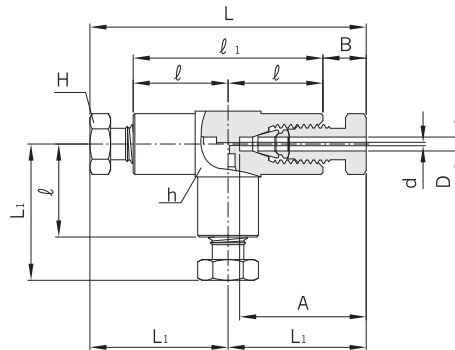

Low Dead Volume Union Tee

Part No.	Tube O.D. D		d Min.	Width across flat				A	B	l	l ₁	L	L ₁
	in	mm		h		H							
				in	mm	in	mm						
CRMTT - 1	1/16	1.58	0.33	5/16	7.93	1/4	6.35	15.49	5.08	11.43	22.86	33.02	16.51

All dimensions are in millimeters unless otherwise specified. Dimensions are for reference only, subject to change.

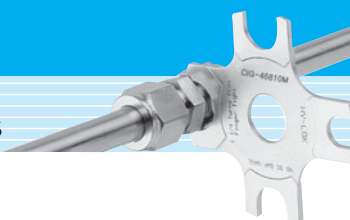

Female Union CCFF

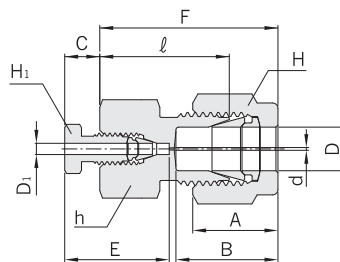

Female Union

Part No.	Tube O.D.				d Min.	Width across flat						A	B	C	E	l
	D		D ₁			h		H		H ₁						
	in	mm	in	mm		in	mm	in	mm	in	mm					
CCFF 4 - 1	1/4	6.35	1/16	1.58	0.33	1/2	12.70	9/16	14.28	1/4	6.35	15.24	17.78	5.08	15.49	19.05
CCFF 6 - 1	3/8	9.52	1/16	1.58	0.33	5/8	15.87	11/16	17.46	1/4	6.35	16.76	19.30	5.08	15.49	20.57

Reducing Union CCEUR

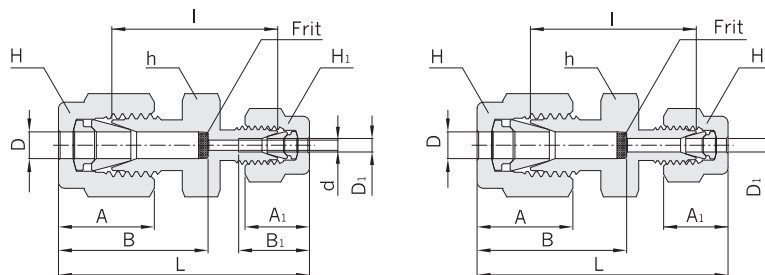

Low Volume

Zero Volume

Reducing Union

Part No.	Tube O.D.				d Min.	Width across flat						A	A ₁	B	B ₁	l	L
	D		D ₁			h		H		H ₁							
	in	mm	in	mm		in	mm	in	mm	in	mm						
CCEUR 2-1-ZV	1/8	3.17	1/16	1.58	0.33	7/16	11.11	7/16	11.11	5/16	7.93	15.24	10.92	18.29	8.64	20.57	30.99
CCEUR 4-1-ZV	1/4	6.35	1/16	1.58	0.33	1/2	12.70	9/16	14.28	5/16	7.93	17.78	10.92	20.83	8.64	23.11	34.29
CCEUR 6-1-ZV	3/8	9.52	1/16	1.58	0.33	5/8	15.87	11/16	17.46	5/16	7.93	19.30	10.92	23.11	8.64	25.40	36.58
CCEUR 8-1-ZV	1/2	12.70	1/16	1.58	0.33	13/16	20.64	7/8	22.22	5/16	7.93	21.84	10.92	26.42	8.64	26.16	40.13
CCEUR 2-1	1/8	3.17	1/16	1.58	1.32	7/16	11.11	7/16	11.11	5/16	7.93	15.24	10.92	18.29	-	20.57	30.99
CCEUR 4-1	1/4	6.35	1/16	1.58	1.32	1/2	12.70	9/16	14.28	5/16	7.93	17.78	10.92	20.83	-	23.11	34.29
CCEUR 6-1	3/8	9.52	1/16	1.58	1.32	5/8	15.87	11/16	17.46	5/16	7.93	19.30	10.92	23.11	-	25.40	36.58

The dead volume in the low volume fitting is equal to the volume of the 0.052" bore.
The tubing in the zero volume fitting is inserted to the frit.

Both low and zero volume column end fittings are available with stainless steel sintered frits. Frits are loosely installed to facilitate removal and replacement. To order, add a frit designator to the ordering number.

Nominal Micron Size	Frit Designator	Nominal Micron Size	Frit Designator
0.1	01	5.0	5
0.25	025	7.0	7
0.5	05	10	10
1.0	1	15	15
2.0	2	20	20
3.0	3	25	25

ex.) CCEUR2-1-ZV-5

All dimensions are in millimeters unless otherwise specified. Dimensions are for reference only, subject to change.

Dielectric Fittings CDF

The Hy-Lok Dielectric tube fittings are for use in applications where electrical current flowing through a pipe or tube line must be interrupted to protect vital instrumentation and metering equipment.

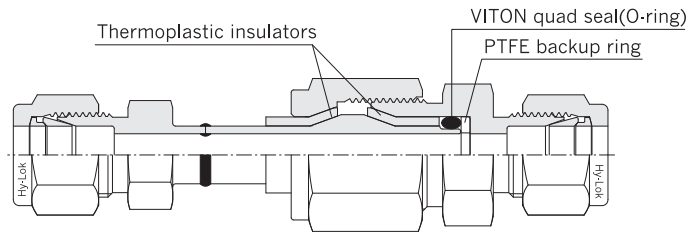

Features

- Metal components are machined from 316 stainless steel for use in rugged environments.
- Thermoplastic insulation with excellent electrical, chemical, ultraviolet resistance and low water absorption maintains dielectric strength and integrity over a wide range of operating and climate conditions.
- Gageable Hy-Lok tube fitting or tapered pipe thread end connections provide direct connection to tubing or piping system.

Benefits

- Maximum safety and protection to critical monitoring station instrumentation.
 - Long component life in rugged environment.
 - Maximum flow capability provided by all sizes of Hy-Lok dielectric tube fittings.
- The unique value and performance offered by Hy-Lok tube fitting connections

Materials

- Body : 316 stainless steel
- Insulations : PEEK
- Quad seal(O-ring) : 70 durometer VITON
- Backup ring : Virgin PTFE

Technical data

- Electrical resistance of insulators @ 70°F(20°C) : $10 \times 10^6 \Omega$ @ 10 V (dc)
- Pressure Rating : 5,000psig (344bar)
- Temperature Rating : -40 to 200°F (-40 to 93°C)

Ordering information / Dimensions

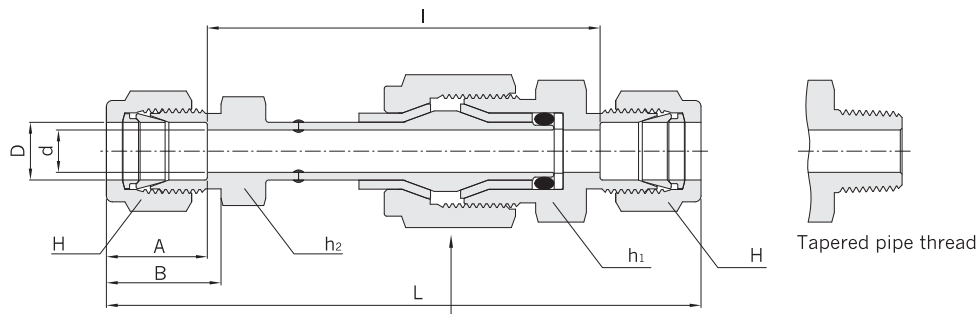

Caution : Do not wrench this hex, nor disassemble this connections.

Part No.	Tube O.D. D		Pipe Thread	d Min.	Width across flat						A	B	ℓ	L
	in	mm			h ₁		h ₂		H					
					in	mm	in	mm	in	mm				
CDF - 4	1/4	6.35	-	4.8	13/16	20.63	1/2	12.70	9/16	14.28	15.24	17.78	65.3	95.8
CDF - 6	3/8	9.52	-	7.1	13/16	20.63	5/8	15.87	11/16	17.46	16.76	19.30	65.8	99.6
CDF - 8	1/2	12.70	-	7.1	13/16	20.63	13/16	20.63	7/8	22.22	22.86	21.84	60.2	106.0
CDF -12M	-	12.00	-	7.1	-	22.00	-	22.00	-	22.00	22.80	22.00	61.7	107.0
CDF6- 4N	3/8	9.52	1/4	7.1	7/8	22.22	5/8	15.87	11/16	17.46	16.76	19.30	73.7	94.7

All dimensions are in millimeters unless otherwise specified. Dimensions are for reference only, subject to change.



Sanitary Flange Fitting CSFC

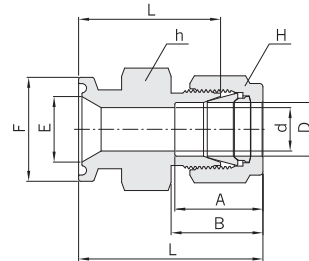

Connectors Fractional Tube To Kwik-Clamp Flange

Part No.	Tube O.D. D		Flange Size	d Min.	Width across flat				A	B	E	F	ℓ	L
	in	mm			h		H							
					in	mm	in	mm						
CSFC 4- 8SC	1/4	6.35	1/2	4.82	1	25.40	9/16	14.28	15.24	17.78	9.40	24.89	24.89	32.51
CSFC 4-12SC	1/4	6.35	3/4	4.82	1	25.40	9/16	14.28	15.24	17.78	15.75	24.89	24.89	32.51
CSFC 4-16SC	1/4	6.35	1	4.82	1 3/8	34.92	9/16	14.28	15.24	17.78	22.10	50.29	50.29	32.51
CSFC 4-24SC	1/4	6.35	1 1/2	4.82	1 3/8	34.92	9/16	14.28	15.24	17.78	24.80	50.29	50.29	32.51
CSFC 6- 8SC	3/8	9.52	1/2	7.11	1	25.40	11/16	17.46	16.76	19.30	9.40	24.89	24.89	34.04
CSFC 6-12SC	3/8	9.52	3/4	7.11	1	25.40	11/16	17.46	16.76	19.30	15.75	24.89	24.89	34.04
CSFC 6-16SC	3/8	9.52	1	7.11	1 3/8	34.92	11/16	17.46	16.76	19.30	22.10	50.29	50.29	34.04
CSFC 6-24SC	3/8	9.52	1 1/2	7.11	1 3/8	34.92	11/16	17.46	16.76	19.30	24.80	50.29	50.29	34.04
CSFC 8- 8SC	1/2	12.70	1/2	10.41	1	25.40	7/8	22.22	22.86	21.84	9.40	24.89	24.89	34.04
CSFC 8-12SC	1/2	12.70	3/4	10.41	1	25.40	7/8	22.22	22.86	21.84	15.75	24.89	24.89	34.04
CSFC 8-16SC	1/2	12.70	1	10.41	1 3/8	34.92	7/8	22.22	22.86	21.84	22.10	50.29	50.29	34.04
CSFC 8-24SC	1/2	12.70	1 1/2	10.41	1 3/8	34.92	7/8	22.22	22.86	21.84	24.80	50.29	50.29	34.04
CSFC16-16SC	1	25.40	1	22.35	1 3/8	34.92	1 1/2	38.10	31.24	26.41	22.10	50.29	50.29	36.32
CSFC16-32SC	1	25.40	2	22.35	1 3/4	44.45	1 1/2	38.10	31.24	26.41	47.50	64.00	64.00	51.05

All dimensions are in millimeters unless otherwise specified. Dimensions are for reference only, subject to change.

Hy-Lok Two Ferrules Tube Fittings

Nut CN

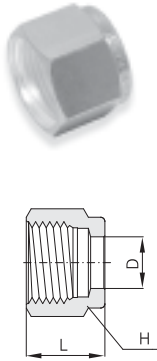

Fractional

Part No.	Tube O.D. D		Width across flat H		L
	in	mm	in	mm	
CN - 1	1/16	1.58	5/16	7.94	7.90
CN - 2	1/8	3.17	7/16	11.11	11.93
CN - 3	3/16	4.76	1/2	12.70	11.93
CN - 4	1/4	6.35	9/16	14.28	12.70
CN - 5	5/16	7.93	5/8	15.87	13.46
CN - 6	3/8	9.52	11/16	17.46	14.22
CN - 8	1/2	12.70	7/8	22.22	17.52
CN - 10	5/8	15.87	1	25.40	17.52
CN - 12	3/4	19.05	1-1/8	28.57	17.52
CN - 14	7/8	22.22	1-1/4	31.75	17.52
CN - 16	1	25.40	1-1/2	38.10	20.57
CN - 20	1-1/4	31.75	1-7/8	47.62	31.75
CN - 24	1-1/2	38.10	2-1/4	57.15	38.10
CN - 32	2	50.80	3	76.20	52.32

Metric

Part No.	Tube O.D. D	Width across flat H	L
CN - 2M	2	12	11.9
CN - 3M	3	12	11.9
CN - 4M	4	12	11.9
CN - 6M	6	14	12.7
CN - 8M	8	16	13.5
CN - 10M	10	19	15.1
CN - 12M	12	22	17.4
CN - 15M	15	25	17.4
CN - 16M	16	25	17.4
CN - 18M	18	30	17.4
CN - 20M	20	32	17.4
CN - 22M	22	32	17.4
CN - 25M	25	38	20.6
CN - 28M	28	46	30.6
CN - 32M	32	50	34.4
CN - 38M	38	60	40.6
CN - 42M	42	65	44.7

Front Ferrule CFF

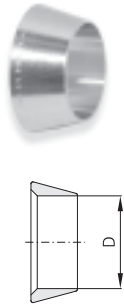

Fractional

Part No.	Tube O.D. D	
	in	mm
CFF - 1	1/16	1.58
CFF - 2	1/8	3.17
CFF - 3	3/16	4.76
CFF - 4	1/4	6.35
CFF - 5	5/16	7.93
CFF - 6	3/8	9.52
CFF - 8	1/2	12.70
CFF - 10	5/8	15.87
CFF - 12	3/4	19.05
CFF - 14	7/8	22.22
CFF - 16	1	25.40
CFF - 20*	1-1/4	31.75
CFF - 24*	1-1/2	38.10
CFF - 32*	2	50.80

Metric

Part No.	Tube O.D. D
CFF - 2M	2
CFF - 3M	3
CFF - 4M	4
CFF - 6M	6
CFF - 8M	8
CFF - 10M	10
CFF - 12M	12
CFF - 15M	15
CFF - 16M	16
CFF - 18M	18
CFF - 20M	20
CFF - 22M	22
CFF - 25M	25
CFF - 28M*	28
CFF - 32M*	32
CFF - 38M*	38
CFF - 42M*	42

Back Ferrule CFB



Fractional

Part No.	Tube O.D. D	
	in	mm
CFB - 1	1/16	1.58
CFB - 2	1/8	3.17
CFB - 3	3/16	4.76
CFB - 4	1/4	6.35
CFB - 5	5/16	7.93
CFB - 6	3/8	9.52
CFB - 8	1/2	12.70
CFB - 10	5/8	15.87
CFB - 12	3/4	19.05
CFB - 14	7/8	22.22
CFB - 16	1	25.40
CFB - 20*	1-1/4	31.75
CFB - 24*	1-1/2	38.10
CFB - 32*	2	50.80

Metric

Part No.	Tube O.D. D
CFB - 2M	2
CFB - 3M	3
CFB - 4M	4
CFB - 6M	6
CFB - 8M	8
CFB - 10M	10
CFB - 12M	12
CFB - 15M	15
CFB - 16M	16
CFB - 18M	18
CFB - 20M	20
CFB - 22M	22
CFB - 25M	25
CFB - 28M*	28
CFB - 32M*	32
CFB - 38M*	38
CFB - 42M*	42

Note : "*" Over1", and 25mm stainless steel fittings use stainless steel ferrules with a PFA coating.

All dimensions are in millimeters unless otherwise specified. Dimensions are for reference only, subject to change.



Ferrule Set CFS



Nut Ferrule Set CNFS



Fractional

Part No.	Tube O.D.		Part No.	Tube O.D.
	in	mm		
CFS - 1	1/16	1.58	CFS - 2M	2
CFS - 2	1/8	3.17	CFS - 3M	3
CFS - 3	3/16	4.76	CFS - 4M	4
CFS - 4	1/4	6.35	CFS - 6M	6
CFS - 5	5/16	7.93	CFS - 8M	8
CFS - 6	3/8	9.52	CFS - 10M	10
CFS - 8	1/2	12.70	CFS - 12M	12
CFS - 10	5/8	15.87	CFS - 15M	15
CFS - 12	3/4	19.05	CFS - 16M	16
CFS - 14	7/8	22.22	CFS - 18M	18
CFS - 16	1	25.40	CFS - 20M	20
			CFS - 22M	22
			CFS - 25M	25

- Hy-Lok ferrule set is composed of one back ferrule and one front ferrule.

Fractional

Part No.	Tube O.D.		Part No.	Tube O.D.
	in	mm		
CNFS - 1	1/16	1.58	CNFS - 2M	2
CNFS - 2	1/8	3.17	CNFS - 3M	3
CNFS - 3	3/16	4.76	CNFS - 4M	4
CNFS - 4	1/4	6.35	CNFS - 6M	6
CNFS - 5	5/16	7.93	CNFS - 8M	8
CNFS - 6	3/8	9.52	CNFS - 10M	10
CNFS - 8	1/2	12.70	CNFS - 12M	12
CNFS - 10	5/8	15.87	CNFS - 15M	15
CNFS - 12	3/4	19.05	CNFS - 16M	16
CNFS - 14	7/8	22.22	CNFS - 18M	18
CNFS - 16	1	25.40	CNFS - 20M	20
			CNFS - 22M	22
			CNFS - 25M	25

- Hy-Lok nut ferrule set is composed of one nut, one back ferrule and one front ferrule.



Fractional

Part No.	Tube O.D.		Part No.	Tube O.D.
	in	mm		
CFS - 1 - SET	1/16	1.58	CFS - 2M - SET	2
CFS - 2 - SET	1/8	3.17	CFS - 3M - SET	3
CFS - 3 - SET	3/16	4.76	CFS - 4M - SET	4
CFS - 4 - SET	1/4	6.35	CFS - 6M - SET	6
CFS - 5 - SET	5/16	7.93	CFS - 8M - SET	8
CFS - 6 - SET	3/8	9.52	CFS - 10M - SET	10
CFS - 8 - SET	1/2	12.70	CFS - 12M - SET	12
CFS - 10 - SET	5/8	15.87	CFS - 15M - SET	15
CFS - 12 - SET	3/4	19.05	CFS - 16M - SET	16
CFS - 14 - SET	7/8	22.22	CFS - 18M - SET	18
CFS - 16 - SET	1	25.40	CFS - 20M - SET	20
			CFS - 22M - SET	22
			CFS - 25M - SET	25

- One ferrule bar is assembled with 10 ferrule sets or 5nut ferrule sets.

Fractional

Part No.	Tube O.D.		Part No.	Tube O.D.
	in	mm		
CNFS - 1 - SET	1/16	1.58	CNFS - 2M - SET	2
CNFS - 2 - SET	1/8	3.17	CNFS - 3M - SET	3
CNFS - 3 - SET	3/16	4.76	CNFS - 4M - SET	4
CNFS - 4 - SET	1/4	6.35	CNFS - 6M - SET	6
CNFS - 5 - SET	5/16	7.93	CNFS - 8M - SET	8
CNFS - 6 - SET	3/8	9.52	CNFS - 10M - SET	10
CNFS - 8 - SET	1/2	12.70	CNFS - 12M - SET	12
CNFS - 10 - SET	5/8	15.87	CNFS - 15M - SET	15
CNFS - 12 - SET	3/4	19.05	CNFS - 16M - SET	16
CNFS - 14 - SET	7/8	22.22	CNFS - 18M - SET	18
CNFS - 16 - SET	1	25.40	CNFS - 20M - SET	20
			CNFS - 22M - SET	22
			CNFS - 25M - SET	25

All dimensions are in millimeters unless otherwise specified. Dimensions are for reference only, subject to change.

Tube Insert for Nylon or Soft Plastic Tubing

CI

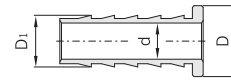

Fractional

Part No.	Tube O.D.		Tube I.D.		Bore I.D.	
	D		D ₁		d	
	in	mm	in	mm	in	mm
CI 3 - 2	3/16	4.76	1/8	3.17	0.09	2.29
CI 4 - 2	1/4	6.35	1/8	3.17	0.09	2.29
CI 4 - 4.3M	1/4	6.35	0.17	4.32	0.11	2.79
CI 4 - 3	1/4	6.35	3/16	4.76	0.14	3.56
CI 5 - 2	5/16	7.93	1/8	3.17	0.09	2.29
CI 5 - 3	5/16	7.93	3/16	4.76	0.12	3.05
CI 5 - 4	5/16	7.93	1/4	6.35	0.19	4.83
CI 6 - 3	3/8	9.52	3/16	4.76	0.12	3.05
CI 6 - 4	3/8	9.52	1/4	6.35	0.19	4.83
CI 8 - 4	1/2	12.70	1/4	6.35	0.19	4.83
CI 8 - 6	1/2	12.70	3/8	9.52	0.31	7.87
CI10 - 6	5/8	15.87	3/8	9.52	0.31	7.87
CI10 - 8	5/8	15.87	1/2	12.70	0.44	11.18
CI12 - 8	3/4	19.05	1/2	12.70	0.44	11.18
CI12 - 10	3/4	19.05	5/8	15.87	0.56	14.22
CI16 - 12	1	25.40	3/4	19.05	0.69	17.53

Metric

Part No.	Tube O.D.	Tube I.D.	Bore I.D.
	D	D ₁	d
CI 6M - 4M	6	4	2.8
CI 8M - 6M	8	6	4.4
CI 10M - 8M	10	8	6.4
CI 12M - 8M	12	8	6.4
CI 12M - 10M	12	10	8.3

Hy-Lok Tube Inserts are used to secure the nylon or other soft plastic tubing to Hy-Lok tube fittings.

To choose the proper Hy-Lok Tube insert, check if O.D. and I.D. of the tubing are the same as dimension D and D₁ of tube inserts, respectively.



Sure Ring Against Overtight

CCL

Hy-Lok Sure Ring is especially useful when you install Hy-Lok two ferrule tube fittings in a small space such as in a cabinet where it is practically impossible to apply the standard installation procedures. (i.e., 1 1/4 turns or 3/4 turn from finger tight) it ensures sufficient tightening and protects over-tightening. For installation, insert Sure Ring between the nut and the body before assembly, and then tighten the nut until being blocked by the sure ring.

Fractional

Part No.	Tube O.D.	
	in	mm
CCL - 2	1/8	3.17
CCL - 4	1/4	6.35
CCL - 6	3/8	9.52
CCL - 8	1/2	12.70
CCL - 12	3/4	19.05
CCL - 16	1	25.40

Metric

Part No.	Tube O.D.
CCL - 3M	3
CCL - 6M	6
CCL - 10M	10
CCL - 12M	12
CCL - 18M	18
CCL - 20M	20
CCL - 25M	25

Bulkhead Retainer

CBRE

Bulkhead retainer can function as a back up wrench, tubing can be installed to side "A" or "B" by one person with only one wrench.

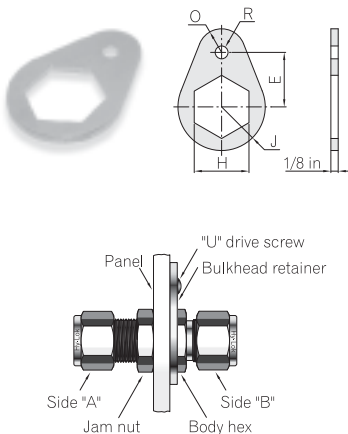

Part No.	Fitting Size		E	H	J	O	R	Drill Hole Dia	"U" Drive Screw Size	Drill Number
	in	mm								
CBRE - 1	1/16	-	9.52	7.93	7.93	3.97				
CBRE - 2	1/8	9.52	12.70	12.70	10.32	5.56				
CBRE - 3	3/16	3.4	14.28	14.28	11.91	6.35				
CBRE - 4	1/4	6	15.87	15.87	12.70	7.14	3.97	3.0	6-3/8	31
CBRE - 5	5/16	-	17.46	17.46	14.28	7.93				
CBRE - 6	3/8	-	19.05	19.05	15.87	8.73				
CBRE - 8	1/2	12	23.81	23.81	19.05	10.32				
CBRE - 10	5/8	15.16	25.40	26.98	20.64	10.23				
CBRE - 12	3/4	18	26.98	30.16	23.02	11.91				
CBRE - 14	7/8	-	28.58	33.33	26.19	13.49	5.56	3.66	10-1/2	27
CBRE - 16	1	-	32.54	41.27	29.37	13.49				
CBRE - 8M	-	8	17.46	18.00	14.28	7.93	3.97	3.0	6-3/8	31
CBRE - 10M	-	10	23.81	22.00	19.05	10.32	5.56	3.66	10-1/2	27

All dimensions are in millimeters unless otherwise specified. Dimensions are for reference only, subject to change.

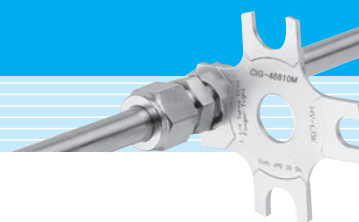

Gap Gauge for Gap Inspection CIG



Multiple Size

Part No.	Tube O.D. in / mm
CIG 46810M	1/4(6mm) 3/8 1/2(12mm) 10mm

Part No.	Tube O.D.	
	in	mm
CIG - 1	1/16	-
CIG - 2M 3M 2	1/8	2, 3
CIG - 4M 3	3/16	4
CIG - 6M 4	1/4	6
CIG - 8M 5	5/16	8
CIG - 6	3/8	-
CIG - 10M	-	10
CIG - 12M 8	1/2	12
CIG - 14M 15M 16M 10	5/8	14, 15, 16
CIG - 18M 12	3/4	18
CIG - 20M 14	7/8	20
CIG - 25M 16	1	25
CIG - 28M	-	28
CIG - 35M	-	35
CIG - 38M	-	38

Tube Marker CTDM

The strong point of Hy-Lok tube marker.

1. Lightweight easy to carry.
2. No damage of the tube surface when inserting and detaching the tube.
3. The visible line on the tube insures that the tubing is fully bottom thereby reducing any chance of leakage.



Instruction of Use

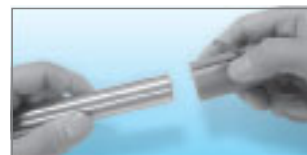

1. Insert the tubing into the tube marker.



2. After inserting the tubing, press the marker lever and rotate the tube marker.



3. Release the marker lever and removing the tubing.



4. Be position the tube on the cutting plane of the product and confirm whether the line on the tube is visible or not.



5. Insert the tubing into the Hy-Lok two ferrule tube fittings and confirm that the line made by the tube marker is not visible. The tube is now properly inserted and the fitting can be tightened.

Fractional

Part No.	Tube O.D	
	in	mm
CTDM - 1	1/16	1.58
CTDM - 2	1/8	3.17
CTDM - 3	3/16	4.76
CTDM - 4	1/4	6.35
CTDM - 5	5/16	7.93
CTDM - 6	3/8	9.52
CTDM - 8	1/2	12.70
CTDM - 10	5/8	15.87
CTDM - 12	3/4	19.05
CTDM - 14	7/8	22.22
CTDM - 16	1	25.40

Metric

Part No.	Tube O.D
CTDM - 2M	2
CTDM - 3M	3
CTDM - 4M	4
CTDM - 6M	6
CTDM - 8M	8
CTDM - 10M	10
CTDM - 12M	12
CTDM - 15M	15
CTDM - 16M	16
CTDM - 18M	18
CTDM - 20M	20
CTDM - 22M	22
CTDM - 25M	25

All dimensions are in millimeters unless otherwise specified. Dimensions are for reference only, subject to change.

Hy-Lok Two Ferrules Tube Fittings

Preswaging Tool CJ



Fractional

Part No.	Tube O.D	
	in	mm
CJ - 1	1/16	1.58
CJ - 2	1/8	3.17
CJ - 3	3/16	4.76
CJ - 4	1/4	6.35
CJ - 5	5/16	7.93
CJ - 6	3/8	9.52
CJ - 8	1/2	12.70
CJ - 10	5/8	15.87
CJ - 12	3/4	19.05
CJ - 14	7/8	22.22
CJ - 16	1	25.40

Metric

Part No.	Tube O.D
CJ - 2M	2
CJ - 3M	3
CJ - 4M	4
CJ - 6M	6
CJ - 8M	8
CJ - 10M	10
CJ - 12M	12
CJ - 15M	15
CJ - 16M	16
CJ - 18M	18
CJ - 20M	20
CJ - 22M	22
CJ - 25M	25

■ For Hy-Lok two ferrule tube fittings installations in close quarters, the Hy-lok preswaging tool is a convenient accessory.

Tee Wrench CTW



Multiple Size

Part No.	Size < Tee or Cross >
CTW-4	1/4 in. and 6mm
CTW-6	5/16 and 3/8 in. and 8mm
CTW-8	1/2 in. and 12mm

■ The tee wrench provides positive backup support when installing Hy-Lok union tees and crosses.

Tube Deburring Tools CTDT



Part No.	Size
CTDT	The inside and outside diameters of 3/16 to 1 1/2in 4 to 38mm tubing

■ When stainless steel, steel and hard alloy tubes are cut by tube cut by tube cutter or tube sawing guide, the tube ends are deburred by Hy-Lok tools.

All dimensions are in millimeters unless otherwise specified. Dimensions are for reference only, subject to change.



Operating Procedures

1. Assemble front ferrule, back ferrule and nut onto jig.
2. Insert the prepared tube into pre-assembled nut and ferrules and hand-tighten the nut. Pumping until arm release (manual), or just press. "start" switch(auto).
3. Unthread nut from swaging jig. Remove pre-swaged tube and insert it into fitting body. Make sure the ferrule seats in the fitting. (The detailed instructions are provided for each of EZY-MAT TOOL.)

EZY - MAT 1 (Manual)

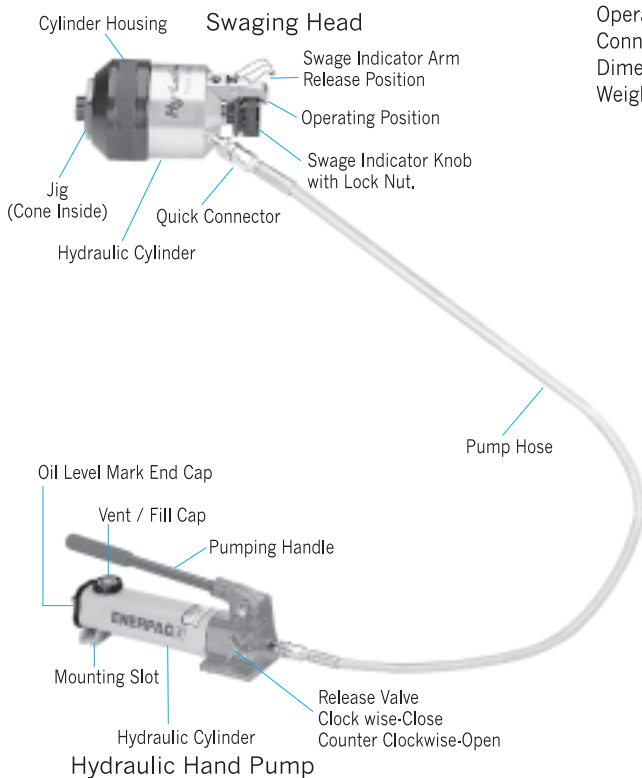

EZY - MAT 2 (Auto)

220V version

Hydraulic pump : 0.35 kW-2.0 ℓ /min.
 Operating pressure : 0~600bar.
 Connection : 220V/1~/50/60 Hz/2.5 A.
 Dimension : 400x400x230 mm.
 Weight : 30kg.

110V version

Hydraulic pump : 0.35 kW-2.0 ℓ /min.
 Operating pressure : 0~600bar.
 Connection : 110V/1~/50/60 Hz/6.5 A.
 Dimension : 400x400x230 mm.
 Weight : 30kg.

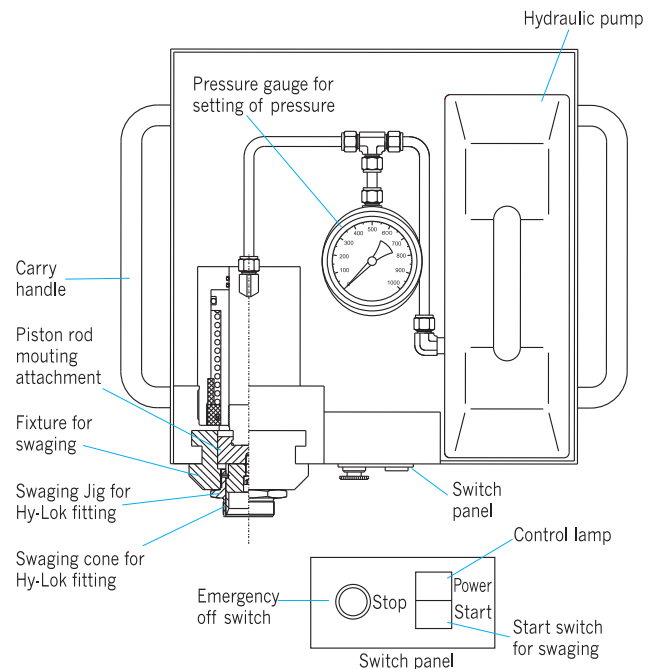

How to Order

EZY - MAT TOOL

Part No.	Applicable Fitting Size	Operation
EZY - MAT 1	1/2" to 2" (12mm to 38mm)	Manual
EZY - MAT 2	1/2" to 2" (12mm to 38mm)	Auto

JIG and DIE

Basic Part No.	Size Designator	Remark
PS - CSJ - *	See below - *	for Jig
PS - CSD - *	See below - *	for Die

Note * : To complete part number, basic part No. must be followed by size designator. For fractional size, designate size in sixteenth and then add T, e.g. 20T for 1 1/4 inches. For metric size, designate size in millimeters and then add M, e.g. 28M for 28mm.

All dimensions are in millimeters unless otherwise specified. Dimensions are for reference only, subject to change.

Applications

- Applications include fire prevention systems, gas supply systems, gas mixing systems, pressure systems, fire alarm systems, liquid pumps and safety release systems.

Features

- Available in brass or 316 stainless steel. The fittings are filled with eutectic material which has melting points of 180°F (71°C), 255°F (124°C), or 281°F(138°C). Melting temperatures are stamped on each points.
- Fittings available in pipe plug, Hy-Lok cap, Hy-Lok plug and Tube adapter configuration
- Sizes available are 1/4", 3/8" and 1/2" NPT and tube
- All fittings machined from barstock
- Maximum working pressure is 250psig(17.3bar)

Used to plug a female pipe port
H-SPBFM

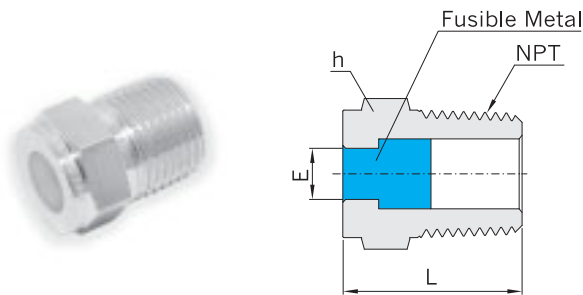

Part No.	Pipe Size	L	E	H Hex.
H-SPBFM - 4N	1/4	24.1	6.4	14.2
H-SPBFM - 6N	3/8	26.9	6.4	17.4
H-SPBFM - 8N	1/2	30.5	8.7	22.2

Used to plug a Tube Fittings
CFTA

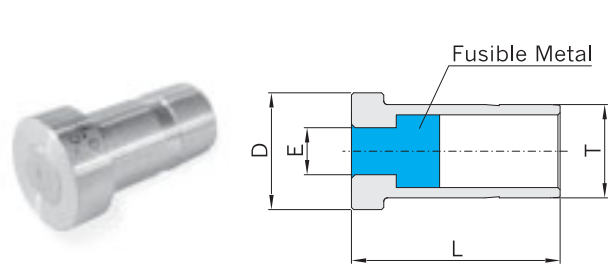

Part No.				
CFTA - 4	1/4	20.6	4.3	9.53
CFTA - 6	3/8	22.4	6.4	12.70
CFTA - 8	1/2	28.4	6.4	15.90

Used to Cap the End of a Tube
CFSC

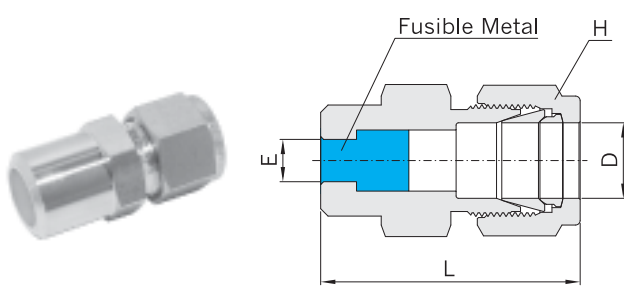

Part No.				
CFSC - 4	1/4	28.7	3.5	14.2
CFSC - 6	3/8	30.5	6.4	17.4
CFSC - 8	1/2	37.6	8.7	22.2

Used to Plug a Tube Fittings Port
CFSP

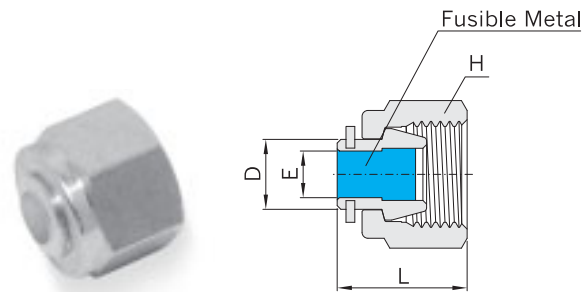

Part No.				
CFSP - 4	1/4	15.0	3.5	14.2
CFSP - 6	3/8	16.3	6.4	17.4
CFSP - 8	1/2	19.6	8.7	22.2

All dimensions are in millimeters unless otherwise specified. Dimensions are for reference only, subject to change.



Installation Instructions

Tube Preparation

1. Check if tubing O.D., wall thickness, ovality, hardness and their tolerances are within specs for your application. Also check if surface is free from scratches and dirt.
2. Make a square cut, (Always use proper tube cutter. Improper tube cutter can cause excessive tube deformation at the tube end.)
3. Remove burrs from inner and outer edges of tubing.

Installation Instructions for Hy-Lok two ferrule tube fittings of 1 inch or 25mm and Under

Hy-Lok two ferrule tube fittings are supplied fully assembled / finger tight and are readily usable. A leak tight and mechanically safe installation is easily made by turning the nut 1 1/4 turns or 3/4 turn for smaller sizes.

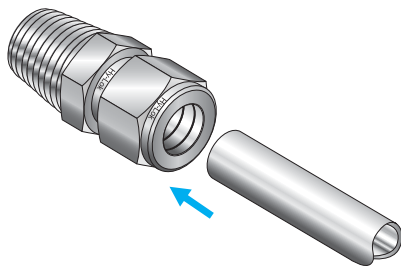

1. Insert prepared tubing into Hy-Lok two ferrule tube fittings until tubing end is firmly seated on the body shoulder making sure the nut is finger-tight. (Do not force the tubing into fitting if it does not go in easily. It may be burred or oval, or there may be foreign materials inside the fitting.)

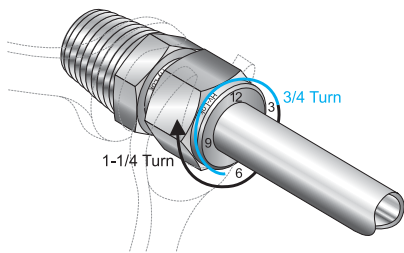

2. Mark the nut at 6 o'clock position for identification of starting point.
3. Tighten the nut 1 1/4 turns* with a wrench keeping the fitting body steady with a back-up wrench. When the nut is tightened 1 1/4 turns, the mark at 6 o'clock position before tightening will be now at 9 o'clock position.

Note*: Only 3/4 turn from finger-tight is required for 1/16", 1/8", 3/16", 2mm, 3mm, and 4mm sizes.

High Pressure Applications

Even though Hy-Lok two ferrule tube fittings are designed to accept the tube variations specified in ASTM or equivalent specifications, it is more desirable to have a common starting point, or snug position, for high pressure applications. Making sure that the tubing end is fully seated, tighten the nut until the tubing can not be rotate by hand, 1 1/4 turns (or 3/4 turn for small size fittings) from snug position will ensure reliable leak tight installation.

Reassembling Instructions

Hy-Lok two ferrule tube fittings can be disassembled and reassembled many times and leak tight performance can be obtained each time.

1. Insert tubing which is preswaged with ferrules into fitting body.
2. Hand tighten the nut and further tighten the nut with a wrench to the original position keeping the body steady with a back-up wrench, When a sharp rise in resistance is felt at the original position, snug slightly with a wrench.

Note : Do not use the gap inspection gauge with reassembled fittings.

Installation of Hy-Lok two ferrule tube fittings larger than 1" : or 25mm

EZY-MAT TOOL, Hy-Lok Corporation's Hydraulic Preswaging Machine, designed for use all Hy-Lok two ferrule tube fittings ranging 1/2"~2" (12mm~38mm).

Hy-Lok Hydraulic Preswaging Unit for Multi - Size Tubes - EZY - MAT TOOL

EZY-MAT TOOL is easy to learn and to operate. With the manual model, the hand pumping requires very little effort the swage indicator arm lets you know when to stop pumping. With the automatic model, preswaging is accomplished by pressing and releasing the start button according to the instruction.

EZY-MAT TOOL can be used for various tube sizes by replacing jig and cone. Two manual models(or just one automatic model) are required for all sizes ranging from 1/2 inch to 2 inch(or 12mm to 38mm). The tool is compact, lightweight and easy to use.

EZY-MAT TOOL reduces make-up torque, and reduces assembly time in the field and prevents the fitting from deformation and damage.

DOs

- DO use Hy-Lok two ferrule tube fittings for best performance.
- DO send us tubing for testing if the wall thickness is thinner or heavier than recommended.
- DO deburr tubing properly prior to installation.
- DO use correct tube cutter to avoid excessive deformation.
- DO ensure tubing is firmly seated on the shoulder of fitting body.
- DO tighten nut according to the installation instructions.
- DO use SURE RING where Hy-Lok needs be installed in close corners or in awkward places.
- DO ensure components are clean and free from dirt prior to installation or remake.

DON'Ts

- DON'T mix metric and fractional size of fitting or tubing.
- DON'T mix components of different materials.
- DON'T force tubing into fitting if it does not fit easily. Check tubing.
- DON'T turn fitting body, turn nut while holding body with back-up wrench.
- DON'T over tighten. It will not improve seal integrity and may cause material fatigue and remake difficult.
- DON'T bleed system pressure by loosening the nut.

SAFETY in FITTING SELECTION

For proper, safe, trouble-free installation, operation and maintenance of fluid systems, material compatibility, pressure/temperature ratings, and application details must be considered in the selection of fittings. Improper selection or intermixing components of other manufactures may cause personal injury or property losses. It is the responsibility of system designer and user to select and use the products for their specific applications.



Distributed by :